

'Hometown Hero'

7-20-02



Sergeant Shannon Gribble of the Newcomerstown Police Department talks to freshman students about law enforcement on Career Day.

Upholding the law runs in Gribble's family as her twin brother, Tom Courts, is a Coshoccon County Deputy, who just recently became a Sergeant. Her children also have shown interest in law enforcement. Currently, Gribble's main case is the garage break-ins that have been occurring since December. When a garage break-in is reported, Gribble will get a written statement from the victim. Information about the last time they were in the garage, was it locked, when they noticed items missing, the makes, models, and values are asked. The next step would be to canvass the neighborhood.

"Sometimes you have to go to them, because a lot of the times people don't want to get involved. Without the public's help, we can't solve a crime." (Continued on Page 9)

Investigators the Matheny the last day of Gribble's family as her twin brother, Tom Courts, is a Coshoccon County Deputy, who just recently became a Sergeant. Her children also have shown interest in law enforcement. Currently, Gribble's main case is the garage break-ins that have been occurring since December. When a garage break-in is reported, Gribble will get a written statement from the victim. Information about the last time they were in the garage, was it locked, when they noticed items missing, the makes, models, and values are asked. The next step would be to canvass the neighborhood.

"Sometimes you have to go to them, because a lot of the times people don't want to get involved. Without the public's help, we can't solve a crime." (Continued on Page 9)

New A



LANE GRIBBLE

Shannon Courts and Bud Gribble are announcing the birth of their son, Lane Curtis Gribble. He was born May 16 and weighed eight pounds, eight ounces.

His grandparents are Ellen Courts, Diana Birker and Larry Gribble, all of Newcomerstown, and Jim Courts, Pennsylvania.

Great-grandparents are Dane and Jane Hursej and Lorna Courts, all of Newcomerstown.

Lane has a sister, Amber, eight, and a brother, Boss, four-years-old.

Hometown Hero

panies.

"We are not the only town that is getting broken into," said Gribble. "Coshoccon also had some break-ins around the time as us and they are still continuing."

Gribble spoke about how the police are labeled as the bad guys, when they are the ones who fight the crime and help

"No matter what the cops have done, they are still labeled as the bad guys. Somebody has to do this job. If it is not me, then someone else. Someone needs to uphold the law.

"Sometimes you just don't feel like you make an impact on what you do, so I thank those people who think highly of me and nominated me for this."

investigators the Matheny the last day of Gribble's family as her twin brother, Tom Courts, is a Coshoccon County Deputy, who just recently became a Sergeant. Her children also have shown interest in law enforcement. Currently, Gribble's main case is the garage break-ins that have been occurring since December. When a garage break-in is reported, Gribble will get a written statement from the victim. Information about the last time they were in the garage, was it locked, when they noticed items missing, the makes, models, and values are asked. The next step would be to canvass the neighborhood.

obtained sev- es along with urce Officer le's biggest hools. ut to the kids. respect there. the schools to overly excit- id's just look mother of 11; Boss ue Gribble, 2. at her oldest tendency to because her stage where more about today's soci-

ndy 8-8433

(Continued from Page 1)

According to Sergeant Gribble, some of the victims of the break-ins have been reimbursed by their insurance companies. When the stolen items are found, the items will be turned into the insurance com-

Our Little Princess Then, Look At You Now Growing Up. Will Be Ten. Feb. 6, 2001 You Mom, Bud, Boss & Lane

AMBER GIBSON



Jan. 31, 2001

We Love Ya, Mom, Bud, Boss & Lane

TEN YEARS AGO - Angie Wilkin and Tom Coutts were chosen queen and king of Newcomerstown High School's prom. Theme for the prom was "Lost in Your Eyes."



Memory Lane

THE NEWCOMERSTOWN NEWS
140 W. Main St., Newcomerstown, Ohio

May 5, 1999

Austin "Boss" Gibson will celebrate his fifth birthday June 11. His parents are Shannon Coutts, Newcomerstown, and Jeff Gibson, Coshocton.
Grandparents are Ellen Coutts, Newcomerstown, and Jim Coutts and Laura and Dave Gibson, all of Pennsylvania.
Great-grandparents are Jane and Dane Hursey and Lorna Coutts, all of Newcomerstown; Donna Schneider, South Carolina, and Gerald and Lois Gibson, Ohio.
Boss has a sister, Amber, eight-years-old, and a brother, Lane, three weeks.



June 8, 1999

Manufactured home park developed at Ne'town

NEWCOMERTOWN

-Creekside Crossing, owned and operated by Steve and Janet Bush at 920 Creekside Dr., is blossoming as a manufactured home park.

In April, the 20-acre devel-

opment was recognized by the Newcomertown Chamber of Commerce when it was presented a Chief Award. The award is for investing in improvements, starting a business or supporting the community over a long period of time without previous acknowledgment.

Janet Bush explained that the development received its manufactured home license Dec. 29 and the first manufactured home resident moved in February. There are 11 homes in the development, including some model homes that are ready to move into.

"We're state approved for 44 lots," Bush explained. The TV service is also available. Creekside is able to provide city water and sewer. Cable service is also available. Creekside is in the Newcomertown corporation, family that located at Creekside from the Dover-New Philadelphia area.

Bush pointed out that one of the residents have no work to do," Bush said. "Steve and the residents have no trash pickup." "It's peaceful, convenient location, monthly rental ranges from \$150 per month to \$175 per month, which includes trash pickup, water and sewer, and lawn care. "They all have a nice view," Bush added.

Creekside Crossing, a manufactured home development at Newcomertown, is approved for 44 lots.

T-R/Jon Conklin



THE NEWCOMERSTOWN NEWS
140 W. Main St., Newcomerstown, Ohio

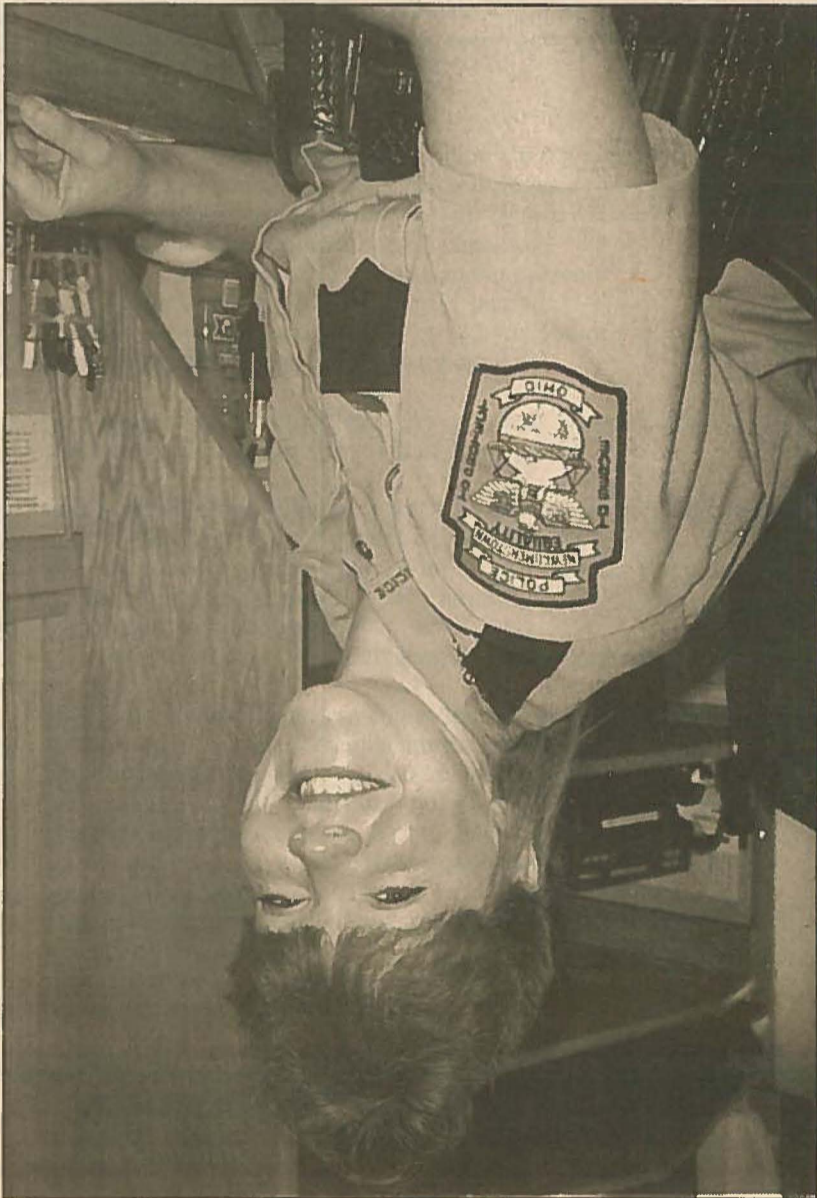

SHANNON GRIBBLE

Native is the first woman to be officer on the force

"KIMBERLEY A. FOUGHTY
Newcomerstown News

A young girl, lost and bewildered at Friday nights Homecoming football game knew who to turn to, the trustworthy one in the gray uniform armed with cuffs, gun, a badge with a name-tag reading Officer Shannon Gribble. Gribble, born and raised in Newcomerstown, had a dream to become an officer of the law. To honor and protect the community, she pursued her six month training course at the Buckeye Career Center located in New Philadelphia affiliated with the Ohio Police Officers Training Association.

In 1996, Gribble began as a reserve officer and dispatcher in 1996, the moved into the community. "At first people yelled 'hey, it's a lady cop,'" explained Gribble. "This is a great opportunity, I'm familiar with the town, the parents and I've always wanted to be an officer." There's a long history of law enforcers in her family and Sgt. Brian Hursey pushed for Gribble's employment with the department and the council was happy to vote for it.

"Sometimes they need a woman for certain situations," said Gribble, "And if I knew that I could help even one person and make a good impression, then I would be satisfied."

Gribble has not only contributed to the police department, but also to the children. She is coach of a t-ball team and also involved with working with local elementary and pre-schools regarding safety issues. Some issues Gribble expresses include bicycle safety, what to do around strangers, and teaching them about violence and precautions to take in case of an emergency.

Incorporating those issues, Gribble will be involved in Kids Day America. There will be seminars on educated the community on procedures in case of an emergency. There will also be identification fingerprinting for the children.

Sept. 22, 1999

8-97

Mom told me:

Cy Young's home was
once Shannon + Bell Co. Co.
farm - (they had a son
named David Co. Co.)



Jessal Marchincavage/Newcomerstown News
Newcomerstown Police Chief Brian Hursey is joined by Sgt. Tim Miller and Sgt Shannon
Gribble, along with Capt. Bob Fisher and other members of the Newcomerstown Emergency
Rescue Squad at the West Lafayette Homecoming Parade on Thursday.

I, Shannon Fisher, give permission
for the Tuscarawas County Genealogical Society to
publish my pedigree chart.

Date 8-11-97

Ne'town students provide holiday

Stephanie Campbell (L) and Amber Gibson, both 6th-graders at Newcomerstown Middle School, make ornaments as part of the Parents, Adolescents and Citizens of the Community Together program Wednesday.

TR/Pat Burk



Thursday, Nov. 28, 2002

L. Eggleston

L. Eggleston, 73, of St., Newcomerstown, Ohio, died at Dover, Ohio, on March 8, 2002.

She was born March 31, 1928, in Newcomerstown, Ohio. She was a graduate of Newcomerstown High School and worked for the late Ernest A. Bourne (Cousins).

She was a 1945 graduate of Newcomerstown High School and worked for the late Ernest A. Bourne (Cousins).

She was a 1945 graduate of Newcomerstown High School and worked for the late Ernest A. Bourne (Cousins).

She was a 1945 graduate of Newcomerstown High School and worked for the late Ernest A. Bourne (Cousins).

She was a 1945 graduate of Newcomerstown High School and worked for the late Ernest A. Bourne (Cousins).

She was a 1945 graduate of Newcomerstown High School and worked for the late Ernest A. Bourne (Cousins).

She was a 1945 graduate of Newcomerstown High School and worked for the late Ernest A. Bourne (Cousins).

Address: 498-8111

THE NEWCOMERSTOWN NEWS
140 W. Main St., Newcomerstown, Ohio



Photograph by Ray Booth

New development
Janet and Steve Bush of Creekside Crossing stand with the sign at their 20-acre development just north of Newcomerstown. The development features the latest in manufactured homes in a landscaped setting. Prospective tenants can pick up from a list of features to create their own home or bring in their own manufactured home, as long as it meets rigid requirements for the development.

Creekside Crossing developments open and ready for homeowners

This isn't your grandmother's trailer park, although it would probably be something that "Grandma and Grandpa" would like to retire. It's the old image of a trailer park that a Newcomerstown couple are working hard to displace as they have taken 20 acres and created a landscaped manufactured home park that features homes better than any "trailer park" ever imagined. "These are nice homes," said Steve and Janet Bush of Newcomerstown, who have purchased Creekside Crossing from Steve's mother.

THE TROPHY CASE

"They have both single and double manufactured homes available and models are open seven days a week for anyone who would like to take a look inside. There are also a number of unique features available so that a family could design their own home based on what is best for them. Manufactured homes can now have built-in decks, sunroofs, huge bedrooms, laundry rooms, vaulted ceilings, real oak woodwork, beautiful kitchens and baths and more. "These are not cheaply made

Name of Compiler Doris Baker
 Address 7968 Church Rd.
 City, State Newcomerstown, OH43832
 Date Feb. 6, 1998

Person No. 1 on this chart is the same person as No. _____ on chart No. _____

Ascetor Chart

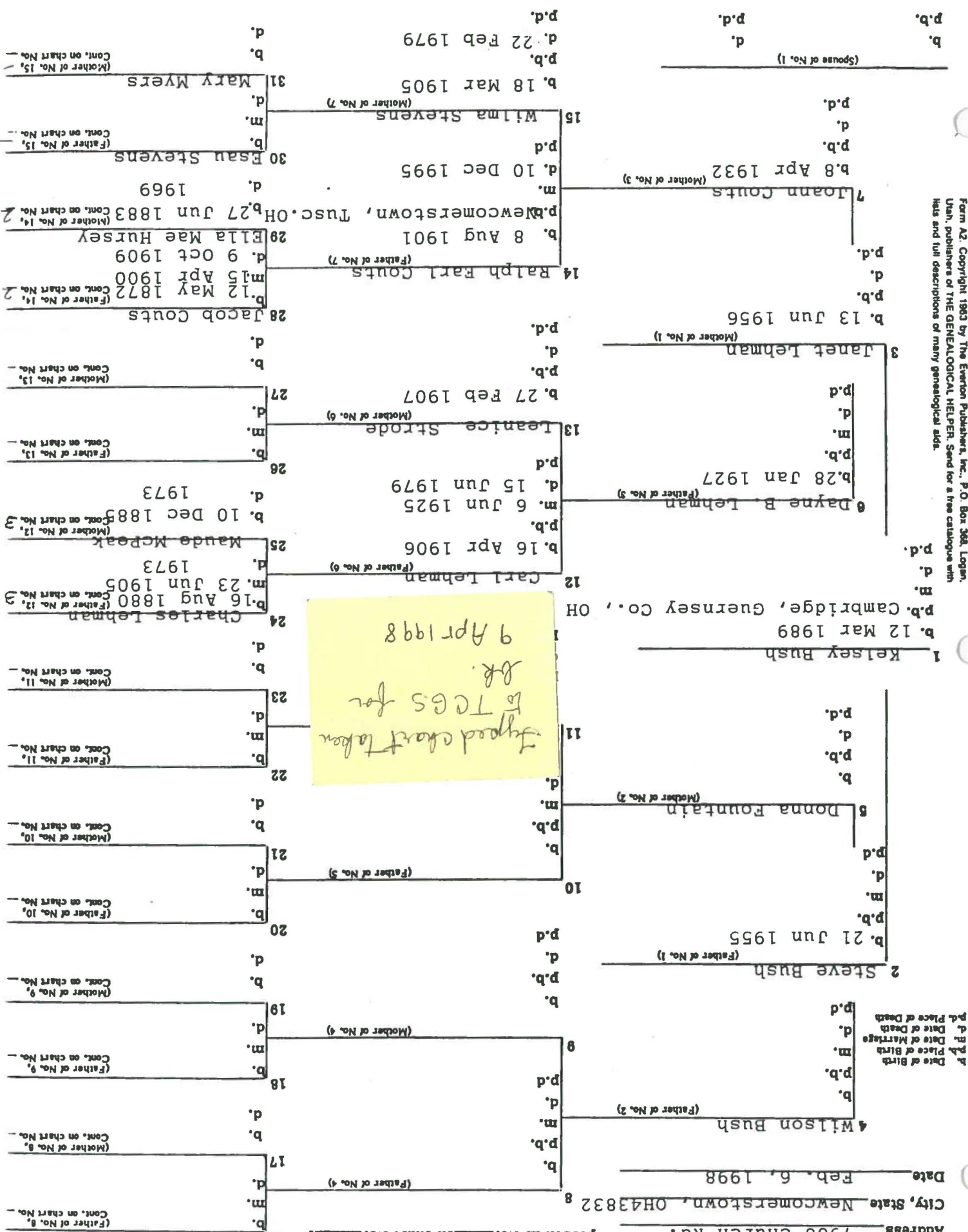
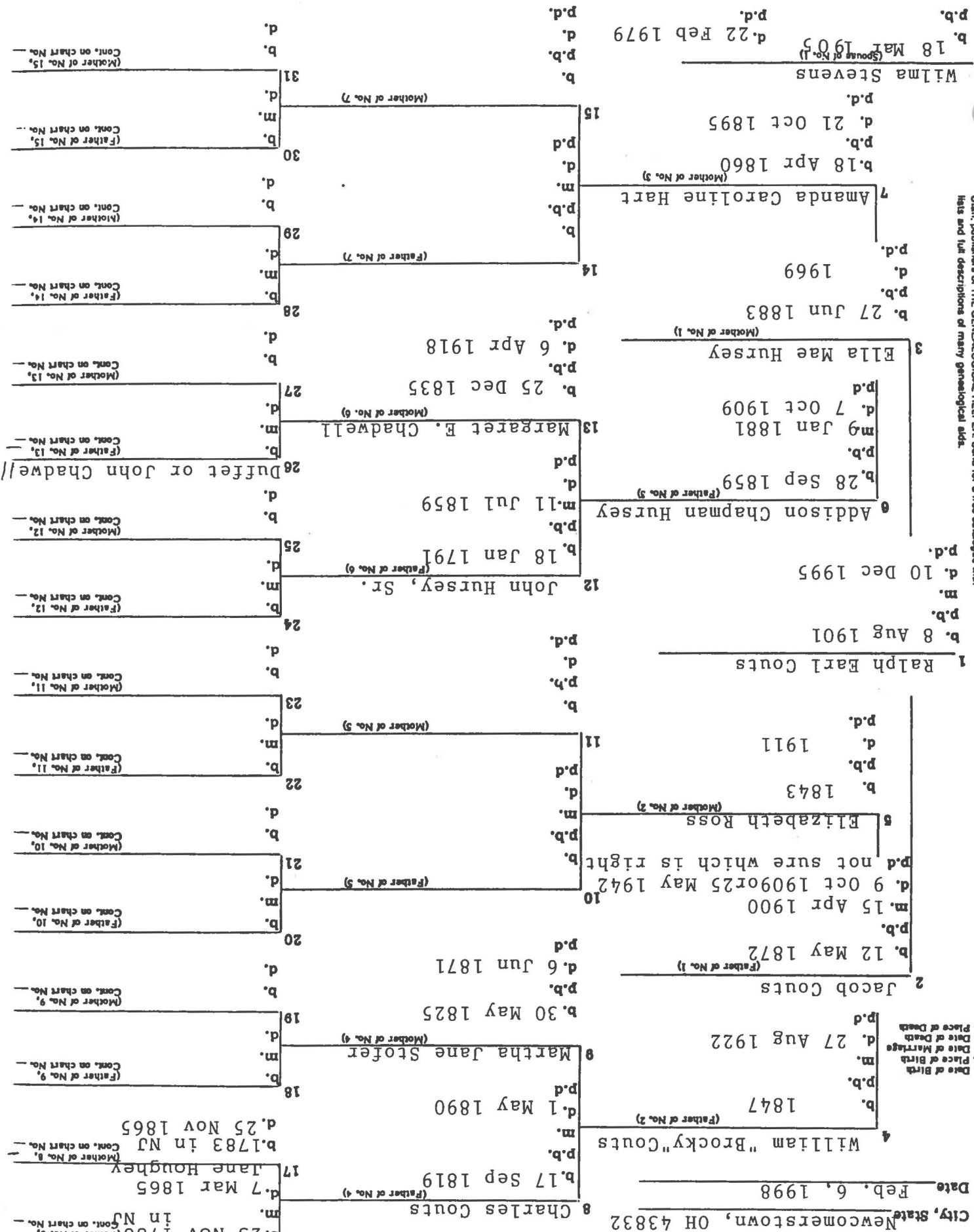

Chart No. 1
 (Father of No. 1)
 (Mother of No. 1)
 (Father of No. 2)
 (Mother of No. 2)
 (Father of No. 3)
 (Mother of No. 3)
 (Father of No. 4)
 (Mother of No. 4)
 (Father of No. 5)
 (Mother of No. 5)
 (Father of No. 6)
 (Mother of No. 6)
 (Father of No. 7)
 (Mother of No. 7)
 (Father of No. 8)
 (Mother of No. 8)
 (Father of No. 9)
 (Mother of No. 9)
 (Father of No. 10)
 (Mother of No. 10)
 (Father of No. 11)
 (Mother of No. 11)
 (Father of No. 12)
 (Mother of No. 12)
 (Father of No. 13)
 (Mother of No. 13)
 (Father of No. 14)
 (Mother of No. 14)
 (Father of No. 15)
 (Mother of No. 15)
 (Father of No. 16)
 (Mother of No. 16)
 (Father of No. 17)
 (Mother of No. 17)
 (Father of No. 18)
 (Mother of No. 18)
 (Father of No. 19)
 (Mother of No. 19)
 (Father of No. 20)
 (Mother of No. 20)
 (Father of No. 21)
 (Mother of No. 21)
 (Father of No. 22)
 (Mother of No. 22)
 (Father of No. 23)
 (Mother of No. 23)
 (Father of No. 24)
 (Mother of No. 24)
 (Father of No. 25)
 (Mother of No. 25)
 (Father of No. 26)
 (Mother of No. 26)
 (Father of No. 27)
 (Mother of No. 27)
 (Father of No. 28)
 (Mother of No. 28)
 (Father of No. 29)
 (Mother of No. 29)
 (Father of No. 30)
 (Mother of No. 30)
 (Father of No. 31)
 (Mother of No. 31)

Name of Compiler Doris Baker
 Address 7968 Church Rd.
 City, State Newcomerstown, OH 43832
 Date Feb. 6, 1998

Successor Chart
 Person No. 1 on this chart is the same person as No. 14 on chart No. 1.



b. Date of Birth
 p.b. Place of Birth
 d. Date of Death
 p.d. Place of Death
 m. Date of Marriage

Name of Compiler Doris Baker

Address 7968 Church Rd.

City, State Newcomerstown, OH 43832

Date Feb. 6, 1998

Successor Chart

Person No. 1 on this chart is the same person as No. 24 on chart No. 1

16 Martin Lehman

b. 1 Jan 1744

m. ---

(Father of No. 8, ---)

d. ---

17 Frederica

b. 4 Mar 1751

m. ---

(Mother of No. 8, ---)

d. ---

18 Rozena McClean

b. ---

m. ---

(Father of No. 4)

d. ---

19 ---

b. ---

m. ---

(Mother of No. 9, ---)

d. ---

20 Samuel Burger

b. ---

m. ---

(Father of No. 5)

d. ---

21 Sarah Burger

b. ---

m. ---

(Mother of No. 2)

d. ---

22 Sarah

b. ---

m. ---

(Father of No. 11)

d. ---

23 ---

b. ---

m. ---

(Mother of No. 5)

d. ---

24 ---

b. ---

m. ---

(Father of No. 12)

d. ---

25 ---

b. ---

m. ---

(Mother of No. 13)

d. ---

26 ---

b. ---

m. ---

(Father of No. 6)

d. ---

27 ---

b. ---

m. ---

(Mother of No. 14)

d. ---

28 ---

b. ---

m. ---

(Father of No. 14)

d. ---

29 ---

b. ---

m. ---

(Mother of No. 14)

d. ---

30 ---

b. ---

m. ---

(Father of No. 15)

d. ---

31 ---

b. ---

m. ---

(Mother of No. 15)

d. ---

1 Charles Lehman

b. 16 Aug 1880

m. 23 Jun 1905

d. 1973

p.d. ---

2 Noah Lehman

b. 14 Dec 1840

m. 12 Apr 1866

d. 13 Mar 1918

p.b. Baltic, Tusc. Co., OH

p.d. Newcomerstown, Tusc. Co., OH

3 Mary Marlett

b. ---

m. ---

(Mother of No. 1)

d. ---

4 Christian Lehman

b. 7 Feb 1807

m. ---

(Father of No. 2)

d. ---

5 Sarah Burger

b. ---

m. ---

(Mother of No. 2)

d. ---

6 Abraham Marlett

b. ---

m. ---

(Father of No. 3)

d. ---

7 Rhunama Fuller

b. ---

m. ---

(Mother of No. 3)

d. ---

8 Christian Lehman

b. 28 May 1778

m. ---

(Father of No. 4)

d. ---

9 Rozena McClean

b. ---

m. ---

(Mother of No. 4)

d. ---

10 Samuel Burger

b. ---

m. ---

(Father of No. 5)

d. ---

11 Sarah

b. ---

m. ---

(Father of No. 11)

d. ---

12 ---

b. ---

m. ---

(Mother of No. 6)

d. ---

13 ---

b. ---

m. ---

(Father of No. 3)

d. ---

14 ---

b. ---

m. ---

(Father of No. 7)

d. ---

15 ---

b. ---

m. ---

(Mother of No. 7)

d. ---

16 Martin Lehman

b. 1 Jan 1744

m. ---

(Father of No. 8, ---)

d. ---

17 Frederica

b. 4 Mar 1751

m. ---

(Mother of No. 8, ---)

d. ---

18 Rozena McClean

b. ---

m. ---

(Father of No. 4)

d. ---

19 ---

b. ---

m. ---

(Mother of No. 9, ---)

d. ---

20 Samuel Burger

b. ---

m. ---

(Father of No. 5)

d. ---

21 Sarah Burger

b. ---

m. ---

(Mother of No. 2)

d. ---

22 Sarah

b. ---

m. ---

(Father of No. 11)

d. ---

23 ---

b. ---

m. ---

(Mother of No. 5)

d. ---

24 ---

b. ---

m. ---

(Father of No. 12)

d. ---

25 ---

b. ---

m. ---

(Mother of No. 13)

d. ---

26 ---

b. ---

m. ---

(Father of No. 14)

d. ---

27 ---

b. ---

m. ---

(Mother of No. 14)

d. ---

28 ---

b. ---

m. ---

(Father of No. 14)

d. ---

29 ---

b. ---

m. ---

(Mother of No. 14)

d. ---

30 ---

b. ---

m. ---

(Father of No. 15)

d. ---

31 ---

b. ---

m. ---

(Mother of No. 15)

d. ---

Form A2, Copyright 1963 by The Everton Publishers, Inc., P.O. Box 368, Logan, Utah, publishers of THE GENEOLOGICAL HELPER. Send for a free catalogue with lists and full descriptions of many genealogical aids.

b. 10 Dec 1885 (Spouse of No. 1)

d. 1973

Maude McPeak

p.d. ---

b. ---

d. ---

p.b. ---

p.d. ---

b. ---

d. ---

p.b. ---

p.d. ---

b. ---

d. ---

p.b. ---

p.d. ---

b. ---

d. ---

p.b. ---

p.d. ---

b. ---

d. ---

p.b. ---

p.d. ---

b. ---

d. ---

p.b. ---

p.d. ---

b. ---

d. ---

p.b. ---

p.d. ---

b. ---

d. ---

p.b. ---

p.d. ---

b. ---

d. ---

p.b. ---

p.d. ---

b. ---

d. ---

p.b. ---

p.d. ---

b. ---

d. ---

p.b. ---

p.d. ---

b. ---

d. ---

p.b. ---

p.d. ---

has and full descriptions of many genealogical data.

Name of Compiler: Dots Baker
 Address: 7968 Church Rd SW, Newcomerstown, OH 43832
 Date: 4-1997

Person No. 1 on this chart is the same person as No. _____ on chart No. _____

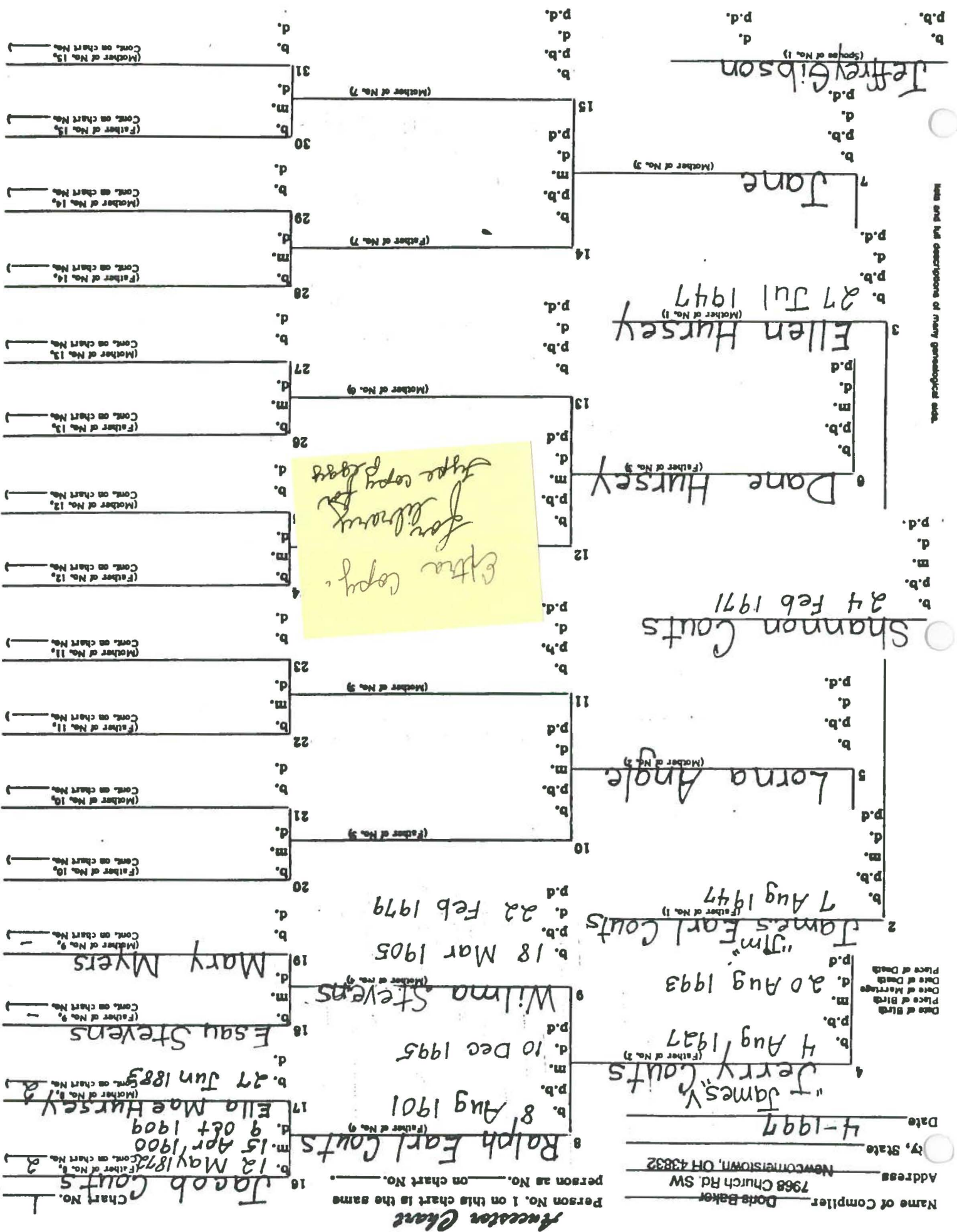

Extra copy for Murray type copy 1988

has and full descriptions of many genealogical data.

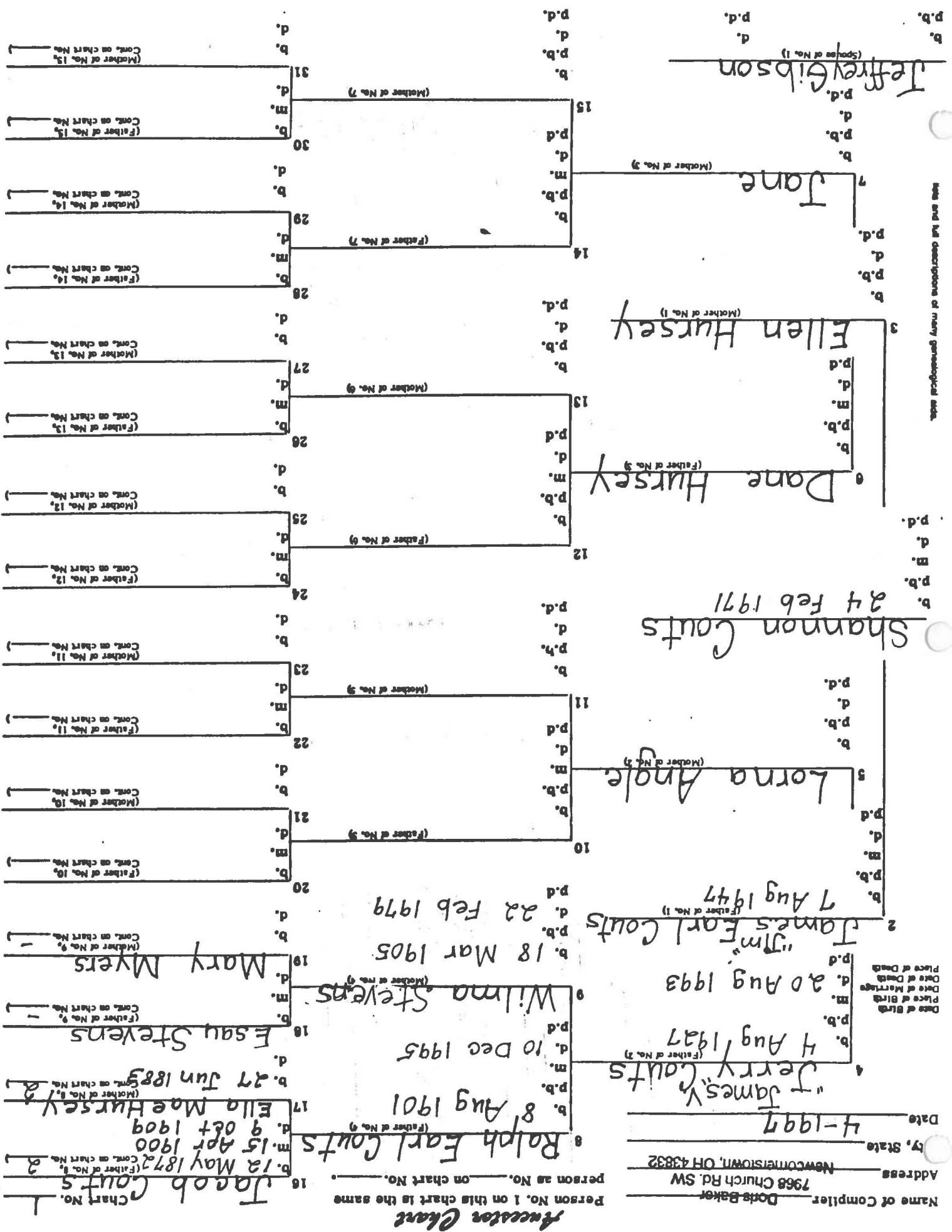

Date of Birth
 Date of Marriage
 Place of Birth
 Date of Death
 Place of Death

Name of Compiler: Dots Baker
 Address: 7968 Church Rd. SW, Newcomerstown, OH 43832
 City, State: _____
 Date: 4-1997

Chart No. 1

(Father of No. 8) Cont. on chart No. _____

(Mother of No. 8) Cont. on chart No. _____

(Father of No. 9) Cont. on chart No. _____

(Mother of No. 9) Cont. on chart No. _____

(Father of No. 10) Cont. on chart No. _____

(Mother of No. 10) Cont. on chart No. _____

(Father of No. 11) Cont. on chart No. _____

(Mother of No. 11) Cont. on chart No. _____

(Father of No. 12) Cont. on chart No. _____

(Mother of No. 12) Cont. on chart No. _____

(Father of No. 13) Cont. on chart No. _____

(Mother of No. 13) Cont. on chart No. _____

(Father of No. 14) Cont. on chart No. _____

(Mother of No. 14) Cont. on chart No. _____

(Father of No. 15) Cont. on chart No. _____

(Mother of No. 15) Cont. on chart No. _____

(Father of No. 16) Cont. on chart No. _____

(Mother of No. 16) Cont. on chart No. _____

(Father of No. 17) Cont. on chart No. _____

(Mother of No. 17) Cont. on chart No. _____

(Father of No. 18) Cont. on chart No. _____

(Mother of No. 18) Cont. on chart No. _____

(Father of No. 19) Cont. on chart No. _____

(Mother of No. 19) Cont. on chart No. _____

(Father of No. 20) Cont. on chart No. _____

(Mother of No. 20) Cont. on chart No. _____

(Father of No. 21) Cont. on chart No. _____

(Mother of No. 21) Cont. on chart No. _____

(Father of No. 22) Cont. on chart No. _____

(Mother of No. 22) Cont. on chart No. _____

(Father of No. 23) Cont. on chart No. _____

(Mother of No. 23) Cont. on chart No. _____

(Father of No. 24) Cont. on chart No. _____

(Mother of No. 24) Cont. on chart No. _____

(Father of No. 25) Cont. on chart No. _____

(Mother of No. 25) Cont. on chart No. _____

(Father of No. 26) Cont. on chart No. _____

(Mother of No. 26) Cont. on chart No. _____

(Father of No. 27) Cont. on chart No. _____

(Mother of No. 27) Cont. on chart No. _____

(Father of No. 28) Cont. on chart No. _____

(Mother of No. 28) Cont. on chart No. _____

(Father of No. 29) Cont. on chart No. _____

(Mother of No. 29) Cont. on chart No. _____

(Father of No. 30) Cont. on chart No. _____

(Mother of No. 30) Cont. on chart No. _____

(Father of No. 31) Cont. on chart No. _____

(Mother of No. 31) Cont. on chart No. _____

(Father of No. 32) Cont. on chart No. _____

(Mother of No. 32) Cont. on chart No. _____

Fractor Chart
Person No. 1 on this chart is the same person as No. _____ on chart No. _____

Name of Compiler: Doris Baker
Address: 7560 Church Rd. SW
Newcomertown, OH 43832
City, State: _____
Date: 1997

Date of Birth
Date of Marriage
Date of Death
Place of Birth
Place of Death

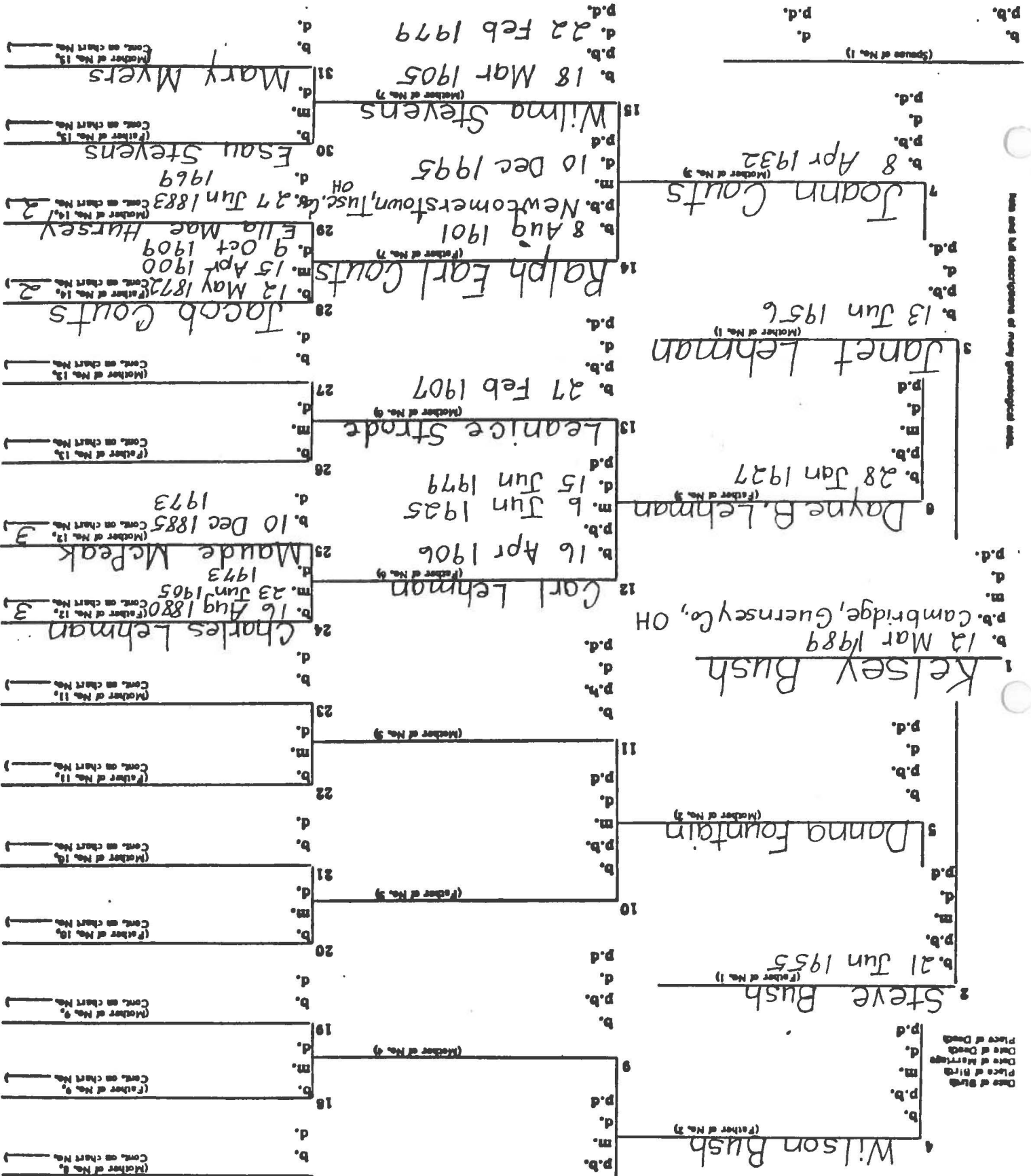

Use and do not duplicate of any genealogical data.

Name of Compiler: Dots Baker
 768 Church Rd. SW
 Newcomerstown, OH 43832

(y, State) _____
 Date: 4-1997
 11-1997 Addition

Date of Birth
 Date of Marriage
 Date of Death
 Place of Birth

Successor Chart
 Person No. 1 on this chart is the same
 person as No. 14 on chart No. 1.

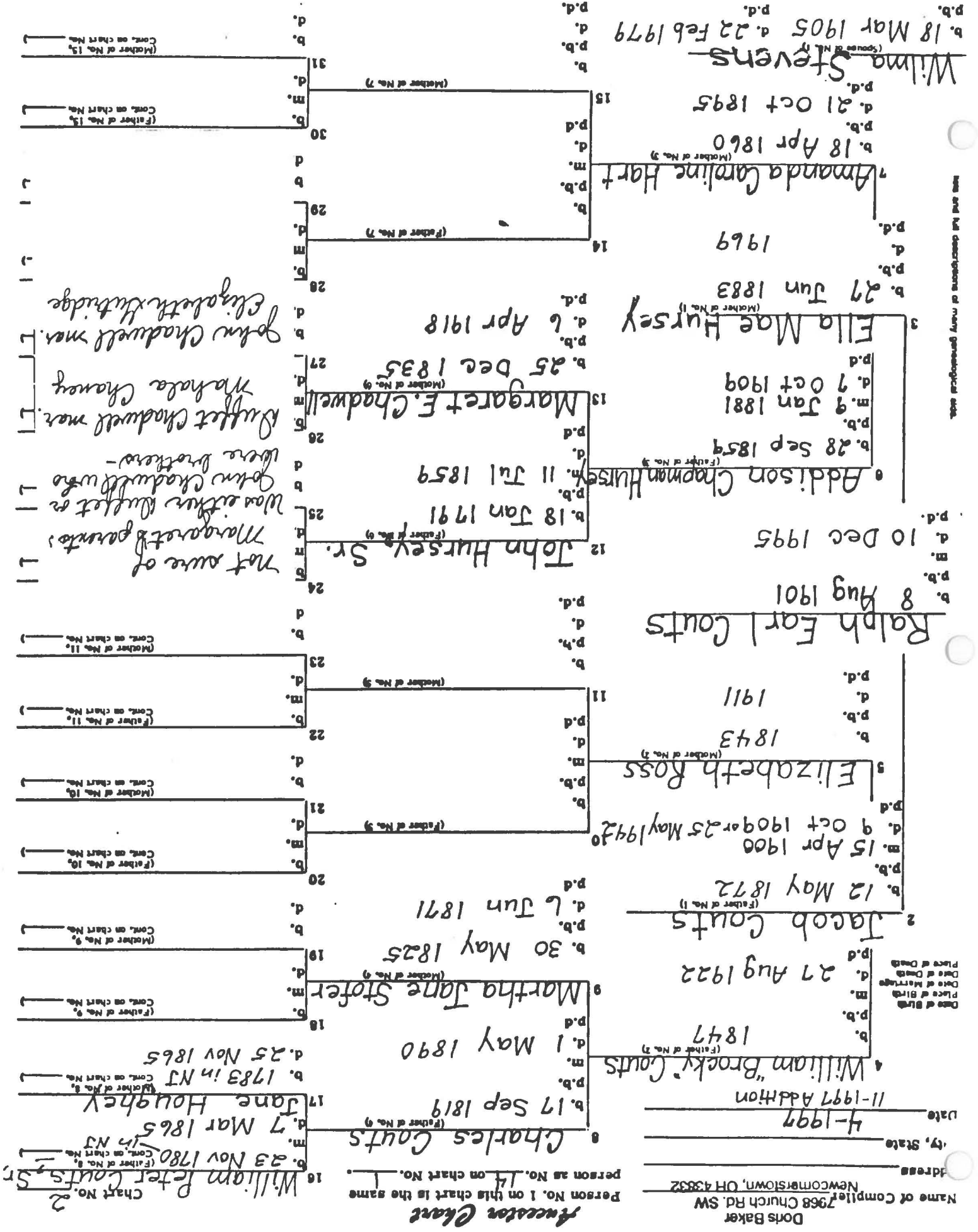

new and old designations of many genealogical data.

Name of Compiler Doris Baker
 Address 7958 Church Rd SW
 City, State Newcomerstown, OH 43832
 Date 1997

Person No. 1 on this chart is the same person as No. 24 on chart No. 1.

Ancestor Chart

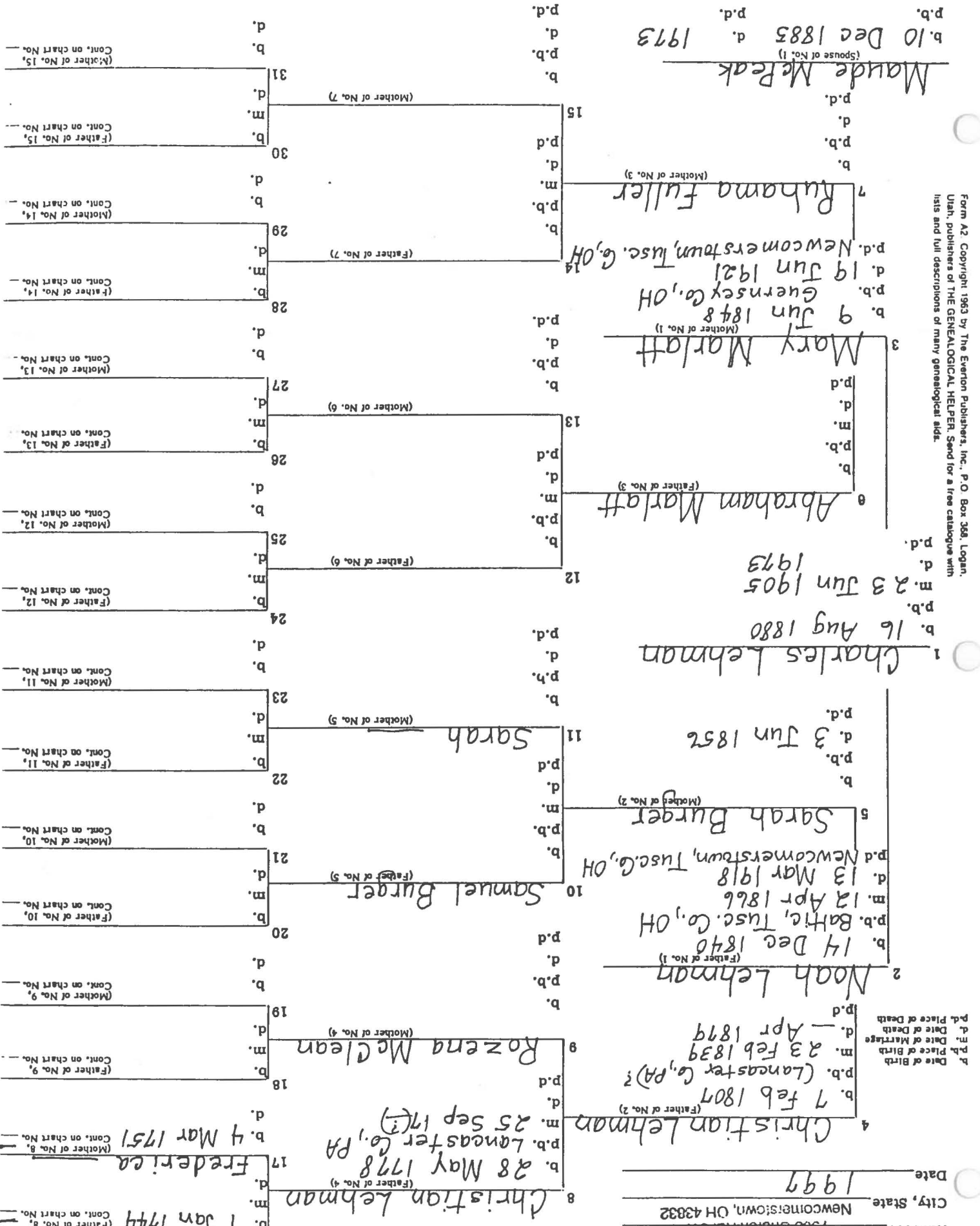

b. Date of Birth
 m. Date of Marriage
 p. Place of Birth
 d. Date of Death
 p.d. Place of Death

COUTS COUSINS

Compiled by
Doris Baker
1997

Acknowledgements:

1. Janet Lehman Bush
2. Shannon Coutts Gibson
3. Sheryl Foraker Hogue
4. Doris Robinson Hooker
5. Joann Coutts Lehman

Books:

Betty Coutts Wolff Book
George Chadwell Family

Tuscarawas Co. Cemeteries, Vol. VI

Family histories are possible only when many people cooperate and contribute. I had many willing helpers to compile these pages. Hopefully, I made very few mistakes. If you find mistakes please let me know. There are several blanks. If you know the meaning of information, fill it in. I suggest you add news clips when you see them. They make a family history so much more interesting. They portray the interests and activities of the individuals. Feel free to make copies of any or all these pages. They were compiled for the enjoyment for anyone interested.

Doris Barber
1968 Church Rd.
Newtown, OH 43832

Name of Compiler: Doris Baker
 7968 Church Rd. SW
 Newcomerstown, OH 43832

Address: _____
 City, State: _____
 Date: 4-1997

11-1997 Addition
 Date of Birth: _____
 Date of Marriage: _____
 Place of Death: _____

Facetor Chart

Person No. 1 on this chart is the same person as No. _____ on chart No. _____

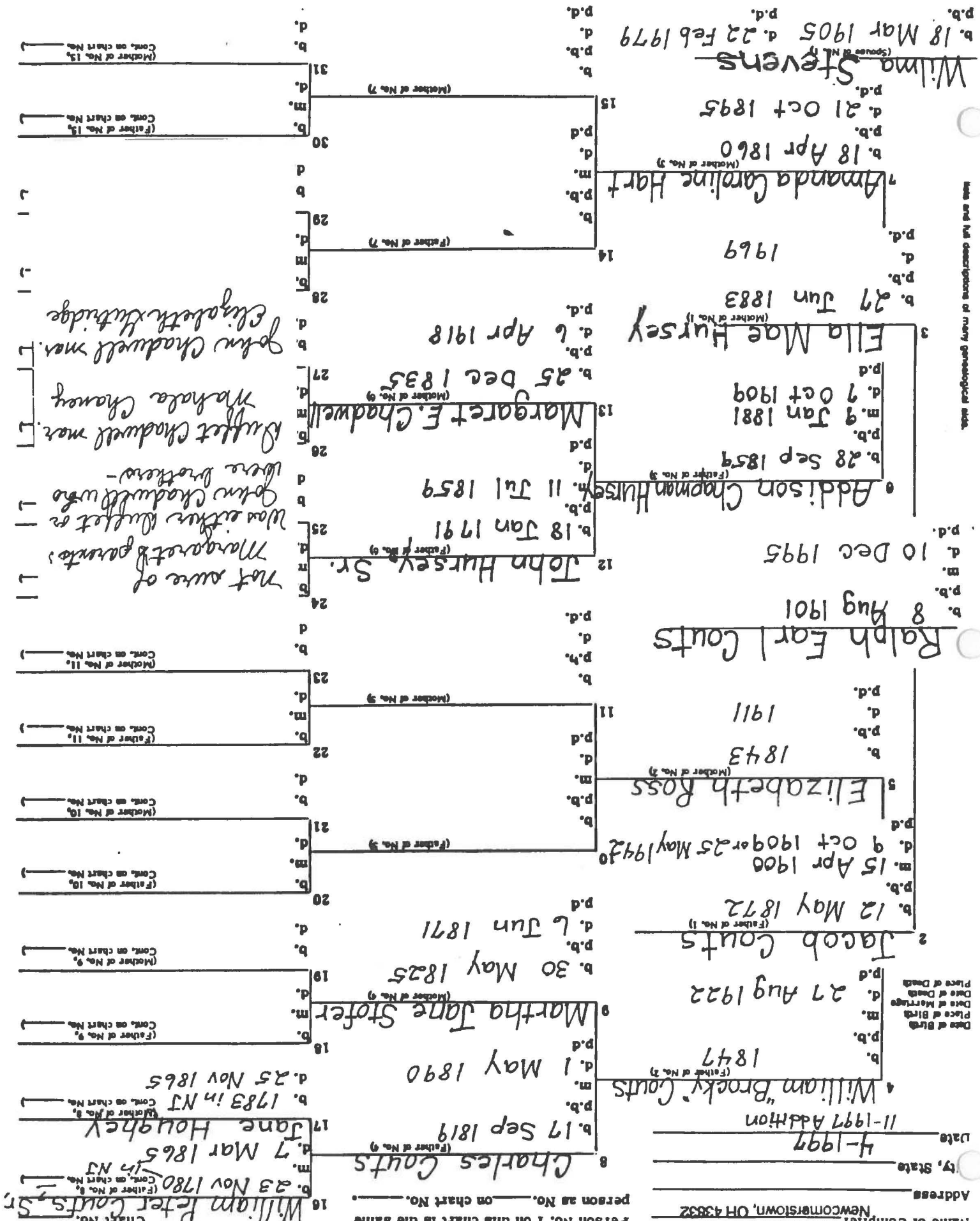

and full descriptions of many genealogical data.

Smith Group Sheet, Form 12
 The form is printed on 5 1/2" x 8 1/2" paper. It is to be filled out by the person who has the most information on the individual. Write in the birth date, burial date, parents (full), sex, reverse side for additional info.

Triplets

Male or Female	CHILDREN (Arrange in order of birth)	WHEN BORN (Day, Month, Year)	WHERE BORN (Town or Place, State or Country)
F	1 Nancy	10 Feb 1805	
F	2 Eleanor	23 Sep 1806	
M	3 James	4 May 1808	
F	4 Cynthia	7 Oct 1811	
M	5 William Peter, Jr.	5 Oct 1813	
F	6 Jane	21 Apr 1815	
M	7 Isaac	4 Apr 1817	
M	8 Charles	17 Sep 1819	
F	9 Elizabeth "Betty"	24 Oct 1821	
F	10 Mary "Aunt Pop"	19 Dec 1821	
F	11 Julia	"	
F	12 Girl triplet	"	
F	13 Ruth Jane	1840	

30 May 1846

Male or Female	CHILDREN (Arrange in order of birth)	WHEN BORN (Day, Month, Year)	WHERE BORN (Town or Place, State or Country)
F	1 Joshua Hartshorn	10 Feb 1805	
F	2 Eleanor	23 Sep 1806	
M	3 James	4 May 1808	
F	4 Cynthia	7 Oct 1811	
M	5 William Peter, Jr.	5 Oct 1813	
F	6 Jane	21 Apr 1815	
M	7 Isaac	4 Apr 1817	
M	8 Charles	17 Sep 1819	
F	9 Elizabeth "Betty"	24 Oct 1821	
F	10 Mary "Aunt Pop"	19 Dec 1821	
F	11 Julia	"	
F	12 Girl triplet	"	
F	13 Ruth Jane	1840	

CAPOTEN (captopril)
 12.5 mg 25 mg 50 mg 100 mg Scored Tablets
 Ph. # 740-498-7446
 NeuroMedicine, PA
 43832
 Delta Ave at: 1118 Hick Run Rd,
 Delta, WV
 a book compiled by Betty
 Courts Wolff.
 Contact Delta Writers to the above
 of William O. Courts, Jr. descendant
 for a complete description

HUSBAND'S NAME
 When Born: 23 Nov 1780, Where: NT
 Christened: 7 Mar 1865, Where: Houghton
 When Died: 7 Mar 1865, Where: Houghton
 When Married: 1997-Courts Family Bk.-by Betty M.
 Other Wives (if any):
 His Father: His Mother's Maiden Name: NT

WIFE'S MAIDEN NAME
 When Born: 1783, Where: NT
 Christened: 25 Nov 1865, Where: Houghton
 When Died: 25 Nov 1865, Where: Houghton
 When Buried: 1997
 Compiler: Ben Baker
 Address: 7968 Church Rd, SW, Newcomerstown, OH 43332
 City: Newcomerstown, OH 43332

HUSBAND'S NAME
 When Born: 23 Nov 1780, Where: NT
 Christened: 7 Mar 1865, Where: Houghton
 When Died: 7 Mar 1865, Where: Houghton
 When Married: 1997-Courts Family Bk.-by Betty M.
 Other Wives (if any):
 His Father: His Mother's Maiden Name: NT

WIFE'S MAIDEN NAME
 When Born: 1783, Where: NT
 Christened: 25 Nov 1865, Where: Houghton
 When Died: 25 Nov 1865, Where: Houghton
 When Buried: 1997
 Compiler: Ben Baker
 Address: 7968 Church Rd, SW, Newcomerstown, OH 43332
 City: Newcomerstown, OH 43332

Date	To
17 Feb 1904	Andrew Stewart
19 Dec 1833	
5 Jul 1842	John F. James

Date	To
10 Feb 1805	Joshua Hartshorn
23 Sep 1806	Eleanor
4 May 1808	James
7 Oct 1811	Cynthia
5 Oct 1813	William Peter, Jr.
21 Apr 1815	Jane
4 Apr 1817	Isaac
17 Sep 1819	Charles
24 Oct 1821	Elizabeth "Betty"
19 Dec 1821	Mary "Aunt Pop"
"	Julia
"	Girl triplet
1840	Ruth Jane

WHEN BORN (Day, Month, Year)	WHERE BORN (Town or Place, State or Country)
10 Feb 1805	
23 Sep 1806	
4 May 1808	
7 Oct 1811	
5 Oct 1813	
21 Apr 1815	
4 Apr 1817	
17 Sep 1819	
24 Oct 1821	
19 Dec 1821	
"	
"	
1840	

0522 202

Family Group Sheet, Form 1-2
 Check 1 written in black ink, 2-5 in North Main Green, 6-7 in red, 8-10 in blue, 11-12 in purple. If burial date is known on children and not death date, write burial date, prefix (burial) for reverse side for additional info.

Male or Female	CHILDREN (Arrange in order of birth)	WHEN BORN	WHERE BORN	Town or Place	State or Country	WHEN DIED	Year	Married
	Day Month Year	Day Month Year				Day Month Year		
M	1 William "Brooky"	1847				27 Aug 1922		
F	2 Elizabeth	1849						
M	3 John	27 Aug 1851				16 Sep 1930		
M	4 Gershom K.	23 Jul 1853				28 Apr 1932		
F	5 Margaret L.	13 Feb 1856				15 Aug 1886		
M	6 Mariah	4 Feb 1861				12 May 1930		
M	7 Nelson							
M	8 Osborn							
M	9 Robert							
F	10 Mary Amanda							

HUSBAND'S NAME
 Charles Coutts
 When Born: 17 Sep 1819, Where: OH
 Christened: 1 May 1890, Where: _____
 When Died: _____, Where: _____
 When Buried: _____, Where: _____
 When Married: _____, Where: _____
 Other Wives (if any): _____
 Number (1) (2) etc.: _____

WIFE'S MAIDEN NAME
 Martha Jane Stoffer
 When Born: 30 May 1825, Where: _____
 Christened: _____, Where: _____
 When Died: 6 Jun 1871, Where: _____
 When Buried: _____, Where: _____
 Other Husb. (if any): _____
 Number (1) (2) etc.: _____

His Father: William Peter Coutts, His Mother's Maiden Name: Jane Haughey

Her Father: _____
 Her Mother's Maiden Name: _____

City: _____
 Address: 7968 Church Rd. SW, Newcomerstown, OH 43832
 Compiler: Doris Baker
 Date: 1997

This information obtained from 1997-Coutts Family Bk. by Betty Wale

(Husband's Full Name) **COUTTS**
 (Wife's Maiden Name) **STOFFER**



DEATH AT PORT
 Mrs. Isaac O. Rhoads, 71, died at her home in Port Washington Tuesday Aug. 22 from the effects of apoplexy. She was born in Tuscarawas county and was the daughter of Mr. and Mrs. Barthelow. She was married twice; her first husband's name was Conklin and the second, Rhoads. Both predeceased her in death. She is survived by two sons, Wesley Conkling of Arizona and Frank Rhoads of

of Baltic.
 Hyle of Stonecreek and Rev. Brown formed church, conducted by Rev. and later at the German residence and later at the Hahn rest-urday afternoon at the Hahn rest- Funeral services were held Saturday 4 months and 15 days. German Reformed church. His age was 82 years, 4 months and 15 days. Mr. Hothem was a member of the children and 9 great grandchildren. 86, of near Bakersville, forty grand- one brother, Adam Hothem, aged of near Bakersville. He also leaves Evansburg and Mrs. Sarah Scharb Vermillion, Mrs. Emma Hoffman of Akron, Mrs. Elizabeth Wasem of Hahn of Flat, Mrs. Mary, Katherine of Newcomertown, Mrs. Katherine erstown, Irvin of Elyria, Oliver north Sandyville, Edward west of Newcom- of near Bakersville, John of near sons and five daughters, are: Chas. 1902. The surviving children, five 21 years. His wife died Nov. 2, in infancy and Lena at the age of services were held Sunday afternoon, James Parks, 85, colored, died Friday, Sep. 1st, of influenza at his home on South College st. He was a native of Virginia. Funeral services were held Sunday afternoon, conducted by Rev. A. I. McCall.

JOHN HOTHEM DIES THURSDAY AT FIAT
 AUGUST 30, 1922
 John Hothem, well-known retired farmer of the Bakersville neighborhood died suddenly Thursday morning, Aug. 24th, while sitting on the porch at the home of his daughter, Mrs. Katherine Hahn of Flat. Mr. Hothem had been in failing health for about a year, but had not been bedfast and went about as usual. On the morning of his death he had arisen and dressed himself as usual, and was sitting in a rocking chair on the porch when he was taken suddenly ill and expired within a few minutes. John Hothem was a native of Germany and was born Apr. 9, 1840. When he was nine years old his parents came to this country and settled near Bakersville, where he spent the remainder of his life. During the Civil War he enlisted and served with the 51st O. V. I. In 1866 he was united in marriage to Elizabeth Baab who bore him thirteen children, two of whom died in infancy and Lena at the age of 21 years. His wife died Nov. 2, 1902. The surviving children, five sons and five daughters, are: Chas. of near Bakersville, John of near Sandyville, Edward west of Newcom- erstown, Irvin of Elyria, Oliver north of Newcomertown, Mrs. Katherine Hahn of Flat, Mrs. Mary, Katherine of Akron, Mrs. Elizabeth Wasem of Vermillion, Mrs. Emma Hoffman of Evansburg and Mrs. Sarah Scharb of near Bakersville. He also leaves one brother, Adam Hothem, aged 86, of near Bakersville, forty grandchildren and 9 great grandchildren. Mr. Hothem was a member of the German Reformed church. His age was 82 years, 4 months and 15 days. Funeral services were held Saturday 4 months and 15 days. German Reformed church. His age was 82 years, 4 months and 15 days. Mr. Hothem was a member of the children and 9 great grandchildren. 86, of near Bakersville, forty grand- one brother, Adam Hothem, aged of near Bakersville. He also leaves Evansburg and Mrs. Sarah Scharb Vermillion, Mrs. Emma Hoffman of Akron, Mrs. Elizabeth Wasem of Hahn of Flat, Mrs. Mary, Katherine of Newcomertown, Mrs. Katherine erstown, Irvin of Elyria, Oliver north Sandyville, Edward west of Newcom- of near Bakersville, John of near sons and five daughters, are: Chas. 1902. The surviving children, five 21 years. His wife died Nov. 2, in infancy and Lena at the age of services were held Sunday afternoon, James Parks, 85, colored, died Friday, Sep. 1st, of influenza at his home on South College st. He was a native of Virginia. Funeral services were held Sunday afternoon, conducted by Rev. A. I. McCall.

COLORED MAN DIES
 SEPTEMBER 13, 1922
 James Parks, 85, colored, died Friday, Sep. 1st, of influenza at his home on South College st. He was a native of Virginia. Funeral services were held Sunday afternoon, conducted by Rev. A. I. McCall.

WILLIAM GOETS
 SEPTEMBER 6, 1922
 William (Brock) Goets, whose death Sunday, Aug. 27, was briefly recorded in these columns last week, was buried Tuesday of last week at Kings U. B. church. Funeral services were conducted by Rev. M. L. Oliver.

WILLIAM GOETS
 SEPTEMBER 6, 1922
 Mr. Goets' death occurred at the home of his daughter, Mrs. Wm. Booth of near Booth school house, Aug. 24th, while sitting on the porch at the home of his daughter, Mrs. Katherine Hahn of Flat. When he was nine years old his parents came to this country and settled near Bakersville, where he spent the remainder of his life. During the Civil War he enlisted and served with the 51st O. V. I. In 1866 he was united in marriage to Elizabeth Baab who bore him thirteen children, two of whom died in infancy and Lena at the age of 21 years. His wife died Nov. 2, 1902. The surviving children, five sons and five daughters, are: Chas. of near Bakersville, John of near Sandyville, Edward west of Newcom- erstown, Irvin of Elyria, Oliver north of Newcomertown, Mrs. Katherine Hahn of Flat, Mrs. Mary, Katherine of Akron, Mrs. Elizabeth Wasem of Vermillion, Mrs. Emma Hoffman of Evansburg and Mrs. Sarah Scharb of near Bakersville. He also leaves one brother, Adam Hothem, aged 86, of near Bakersville, forty grandchildren and 9 great grandchildren. Mr. Hothem was a member of the German Reformed church. His age was 82 years, 4 months and 15 days. Funeral services were held Saturday 4 months and 15 days. German Reformed church. His age was 82 years, 4 months and 15 days. Mr. Hothem was a member of the children and 9 great grandchildren. 86, of near Bakersville, forty grand- one brother, Adam Hothem, aged of near Bakersville. He also leaves Evansburg and Mrs. Sarah Scharb Vermillion, Mrs. Emma Hoffman of Akron, Mrs. Elizabeth Wasem of Hahn of Flat, Mrs. Mary, Katherine of Newcomertown, Mrs. Katherine erstown, Irvin of Elyria, Oliver north Sandyville, Edward west of Newcom- of near Bakersville, John of near sons and five daughters, are: Chas. 1902. The surviving children, five 21 years. His wife died Nov. 2, in infancy and Lena at the age of services were held Sunday afternoon, James Parks, 85, colored, died Friday, Sep. 1st, of influenza at his home on South College st. He was a native of Virginia. Funeral services were held Sunday afternoon, conducted by Rev. A. I. McCall.

MRS. CAMPBELL DIES
 Mrs. Jennie Campbell, 75, former resident of Newcomertown, died at 3 p. m. Sunday at the county infirmary near New Philadelphia since Dec. 28, 1919. She suffered a general breakdown, resulting in her death four days later. She is survived by one son, Walter Campbell, who is confined in the state institution for epileptics at Gallipolis. Jones' ambulance removed the body to Newcomertown last Sunday. Funeral services were held this Wednesday morning at 10 o'clock at the M. E. church, Rev. C. M. Hartshorn officiating. Burial was made in the local cemetery.

MRS. CAMPBELL DIES
 Mrs. Jennie Campbell, 75, former resident of Newcomertown, died at 3 p. m. Sunday at the county infirmary near New Philadelphia since Dec. 28, 1919. She suffered a general breakdown, resulting in her death four days later. She is survived by one son, Walter Campbell, who is confined in the state institution for epileptics at Gallipolis. Jones' ambulance removed the body to Newcomertown last Sunday. Funeral services were held this Wednesday morning at 10 o'clock at the M. E. church, Rev. C. M. Hartshorn officiating. Burial was made in the local cemetery.

WILLIAM F. DAVIS
 SEPTEMBER 13, 1922
 William Fowler Davis, retired Penna. railroad crossing watchman, died Saturday, Sept. 9th, at his home on River st., this city, after a five-year illness of hardening of the arteries. His age was 72 years, 6 months and 4 days. Despite his serious affliction and the great care involved in attending the sick man, the faithful wife and son remained steadfast during his long illness, maintaining a ceaseless vigil over him. William F. Davis was a son of James and Christina Davis, and was born Apr. 5, 1850, in Coshocton county where he resided until about 31 years ago when he moved to this vicinity. He was married in 1877 to Sintha Martitt, and is survived by his wife and one son, William Emer- son Davis. He also leaves three brothers, Marion and John of this city, Presley Davis of Plainfield, and one sister, Mrs. Ida Denzer of Dennison. During his early life Mr. Davis was a successful farmer and well-known horseman. After his removal to this vicinity, he became an employe of the Penna. Ry., continuing in this work until forced to quit work on account of ill health five years ago. He was a member of the Lutheran church and was highly respected for his honorable dealings and upright manner of living. Funeral services were held at the residence Monday afternoon at 2 o'clock, conducted by Rev. W. L. Husser. Music was furnished by the Lutheran choir. Interment in the local cemetery.

PASSES AWAY SEP. 9

Family Group Sheet, Form 12
 Give 1 version Turkish etc, 2/20 North Main Street, Logan, Utah
 If burial date is known on children and not death date, write
 burial date, prefix (bur) for reverse side for additional info.

Male or Female	CHILDREN (Arrange in order of birth)	WHEN BORN Day Month Year	WHERE BORN Town or Place County State or Country	WHEN DIED Day Month Year	Married
F	1 Mary Jane "Dodi" Arminda "Mindy"	5 Apr 1868		3 Jul 1948	Dec 1894
F	2 Sarah	5 Nov 1871			
M	3 Jacob	12 May 1872		25 May 1942	Frank Ripley
M	4 Joshua	28 Feb 1875		9 Jun 1946	Ella Hursey
F	5 Josephine	1876		1926	Howard "Jose" S. Bliss
F	6 Callie	1878		1885	
F	7 Ida B.	15 Jun 1879		1976	9 Jul 1899 To William A. Booth
M	8 Ernest Arizona	12 Sep 1881		24 Jul 1970	Date#2 - Dara Lee Bourne To - Cora Mae Neighbor
	10				
	11				
	12				
	13				

HUSBAND'S NAME
 William "Rocky" Coats
 1847

WIFE'S MAIDEN NAME
 Elizabeth Ross
 1843

When Born: _____ Where: _____
 Christened: _____ Where: _____
 When Died: _____ Where: _____
 When Buried: _____ Where: _____
 Other Husb. (if any): _____
 Number (1) (2) etc. _____

His Father: Charles Coats
 His Mother's Maiden Name: Martha Jane Stoffer

When Married: _____ Where: _____
 When Buried: _____ Where: _____
 When Died: 27 Aug 1922
 Christened: _____ Where: _____
 (Husband's Full Name) **COATS**
 (Wife's Maiden Name) **ROSS**

This information obtained from 1997 Coats Family Bk. Betty Ross
 Doris Baker
 7908 Church Rd SW
 Newcomerstown, OH 43832
 Date: 1997
 Compiler: _____
 Address: _____
 City: _____
 Her Father: _____
 Her Mother's Maiden Name: _____

Male or Female (Arrange in order of birth)	WHEN BORN Day Month Year	WHERE BORN Town or Place	State or Country	WHEN DIED Day Month Year	Married
2					
3					
4					
5					
6					
7					
8					
9					
10					
11					
12					
13					

HUSBAND'S NAME John Hursey, Sr. 18 Jan 1791
 When Born _____ Where _____
 Christened _____ Where _____
 When Died _____ Where _____
 When Buried _____ Where _____
 When Married 11 Jul 1859 _____ Where _____
 Other Wives (if any) _____ Number (1) (2) etc. _____

WIFE'S MAIDEN NAME ^{2nd wife} Margaret E. Chadwell 25 Dec 1835
 When Born _____ Where _____
 Christened _____ Where _____
 When Died 6 Apr 1918 _____ Where _____
 When Buried _____ Where _____
 Other Husb. (if any) _____ Number (1) (2) etc. _____

Her Father _____
 Her Mother's Maiden Name _____

City _____
 Address 7968 Church Rd. SW Newcomerstown, OH 43832
 Compiler Doris Baker
 Date 4-1997

(Husband's Full Name) HURSEY
 (Wife's Maiden Name) CHADWELL
 This information obtained from Mrs. Chadwell Family - TGS

M Addie Chapman 38 Sep 1859
 Date 7 Jan 1881 To Amanda, G. Hunt
 Date 7 Oct 1909 To _____

CHILDREN Made or Female (Arrange in order of birth)	WHEN BORN Day Month Year	WHERE BORN Town or Place Country	WHEN DIED Day Month Year	Married
F 1 Ella Mae	27 Jun 1883		1969 Date #1 - Oard (buried) To #2 - Harry Tomlinson	
M 2 Charles	31 Aug 1886		9 Jan 1890 To - died age 3 y 4 m 10 d	

HUSBAND'S NAME Addison Chapman Hursey
 When Born: 28 Sep 1859
 Where: [Blank]
 Christened: [Blank] (Was 1st editor of Newcomerstown Index)
 When Died: 7 Oct 1909
 When Buried: [Blank] Where: [Blank]
 When Married: 7 Jan 1881
 Where: [Blank]
 Other Wives (if any): [Blank]
 Number (1) (2) etc.: [Blank]

WIFE'S MAIDEN NAME Amanda Caroline Hart
 When Born: 18 Apr 1860
 Where: [Blank]
 Christened: [Blank] Where: [Blank] (age 3 y 6 m 3 d)
 When Died: 21 Oct 1895
 Where: [Blank]
 When Buried: [Blank] Where: [Blank] (Peoples Cem.)
 Other Husb. (if any): [Blank]
 Number (1) (2) etc.: [Blank]

Her Father John Hursey, Sr.
 His Mother's Maiden Name: Margaret E. Chadwell
 Address: [Blank] City: [Blank] State: [Blank]

Her Mother's Maiden Name [Blank]
 Address: 7968 Church Rd. SW, Newcomerstown, OH 43832
 City: [Blank] State: [Blank]
 Compiler: Doris Baker
 Date: 4-1997

HURSEY (Husband's Full Name)
HART (Wife's Maiden Name)
 This information obtained from [Blank]
 [Blank] x1997
 [Blank] [Blank] [Blank]

CHILDREN Male or Female (Arrange in order of birth)	WHEN BORN Day Month Year	WHERE BORN Town or Place	State or Country	WHEN DEED* Day Month Year	Married
M ¹ Ralph Earl	8 Aug 1901	Newcomerstown	OH	10 Dec 1993	
M ² Lloyd Raymond	11 Apr 1906	"	"	30 Apr 1984	
F ³ Odith Charlene	7 Sep 1911	Booth	"	22 Sep 1993	
M ¹ Wilma Stearns					

HUSBAND'S NAME Jacob "Jake" Courts
When Born 12 May *1872
Christened 9 Oct 1909 Δ 25 May 1942
When Died Where
When Married 15 Apr 1900
When Buried Peoples Cem., Oxford Twp., Tus. Co., OH
Other Lives (if any) Number (1) (2) etc.
His Father William "Brocky" Courts
His Mother's Maiden Name Elizabeth Ross
WIFE'S MAIDEN NAME Ella Mae Hursey
When Born 27 Jun 1883
Christened 1969
When Died 1969
When Buried Peoples Cem., Oxford Twp., Tus. Co., OH
Other Husb. (if any) Number (1) (2) etc. #3 - Harry Fontenmaker - no name
Her Father Addison C. Hursey
Her Mother's Maiden Name Amanda C. Hart
Address 7968 Church Rd. SW, Newcomerstown, OH 43832
City Newcomerstown, OH 43832
State OH
Compiler Dora Baker
Date 4-1997
This information obtained from Mrs. Chadwell Family - TGS 1997 - Gen. & Rem. 1997 - Cem. - Granestone 1997 - Charles Robinsobn 1997 - Courts - Fam. Bk. by Burt W.

COULTS
HURSEY
 (Husband's Full Name)
 (Wife's Maiden Name)

Family Group Sheet, Form 12
 If the 1st written birth date is known on children and not the date, write
 "burial date" is known on children and not the date, write
 "burial date, prefix (burial date) or reverse side for additional info.

Male or Female (Arrange in order of birth)	WHEN BORN Day Month Year	WHEN BORN Town or Place	State or Country	WHEN DECEASED Day Month Year	Married
F 1	# 7 May 1921			# 17 Feb 1990	To John Stevens
F 2	# 3 Sep 1922				To Raymond Higgins
M 3	# 4 Aug 1927			# 20 Aug 1993	To #1 Norma Angles, #3-14-1111 #3-14-1111
F 4	# 8 Apr 1932				To Raymond Johnson
F 5	# 15 Feb 1937				To Raymond Brown
					To
					To
					To
					To
					To
					To
					To
					To
					To
					To
					To
					To

HUSBAND'S NAME
 Ralph Earl Courts
 # 8 Aug 1901
 Where: Newcomertown, Warrick Co, Indiana
 * Member of Peoples Community Church, 1000 Farmers + Workers @ Church

WIFE'S MAIDEN NAME
 Wilma G. Stevens
 # 18 Mar 1905
 Where:
 When Born:
 Christened:
 When Died: # 22 Feb 1979
 Where:
 When Buried:
 Where Buried: Peoples Cem.

Her Father: Esau Stevens
Her Mother's Maiden Name: Mary Myers
 City:
 Address: Newcomertown, OH 43832
 Compiler: Doris Baker
 Date: 4-1997

Other Males (if any): Jacob Courts
 # 10 Dec 1995
 When Died:
 Where:
 When Buried:
 Where Buried: Peoples Cem.

Other Males (if any): Ella Mae Hursey
 # 1997 - (Dist. Carl Courts)
 # 1997 - (John Johnson)
 # 1997 - (Mrs. Chadwell Family, etc.)

This information obtained from:
 (Wife's Maiden Name) **STEVENS**
 (Husband's Full Name) **COURTS**

Grandson follows footsteps as trustee

BY MRS. BERT SILVIUS

More than a quarter century of service was represented by a township trustee and his grandson, who were among the special guests at the annual spring banquet of the Tuscarawas County Assn. of Twp. Trustees and Clerks.

Earl Couls, Newcomertown R.D. 3, and his grandson, James Earl Couls, 430 Pearl St., Newcomertown, both Oxford Twp. trustees, have the distinction of being the only grandfather-grandson combination holding township offices, as far as Mrs. Mildred Cronbaugh, Stone Creek R.D. 1, can discover. She is secretary-treasurer of the county's township officers.

The elder Couls ran for trustee first in 1961 because of a challenge that no one on the north side of the Tuscarawas River would be elected as a township trustee because of the smaller pocket of population on that side. Couls has now been elected for five consecutive terms and is now in his 20th year of service.

Although it is Earl's final year, his grandson said he is sure his grandfather would be elected if he chose to run for a sixth term. Jim, now 30, was only 11 years old when his grandfather was first elected. He often went with him cut brush and clean out culverts. Those years influenced his decision to run for trustee and he was elected when he was 25 years old. He is in his sixth year as a trustee. He is vice president of the Oxford Twp. trustees and is their representative on the Tuscarawas County board of health, Tuscarawas County regional planning commission and the Tri-County Ambulance Service board.

An employee of Conrail, Jim and his wife, Ellen, have three children. His grandfather is a retired employee of the Eureka Hardware Store in Newcomertown, where he worked for 27 years. He is still an active farmer on 193 acres. Earl also reported he became a great-grandfather again recently. He has five children and 17 grandchildren. He now has 14 great-grandchildren.

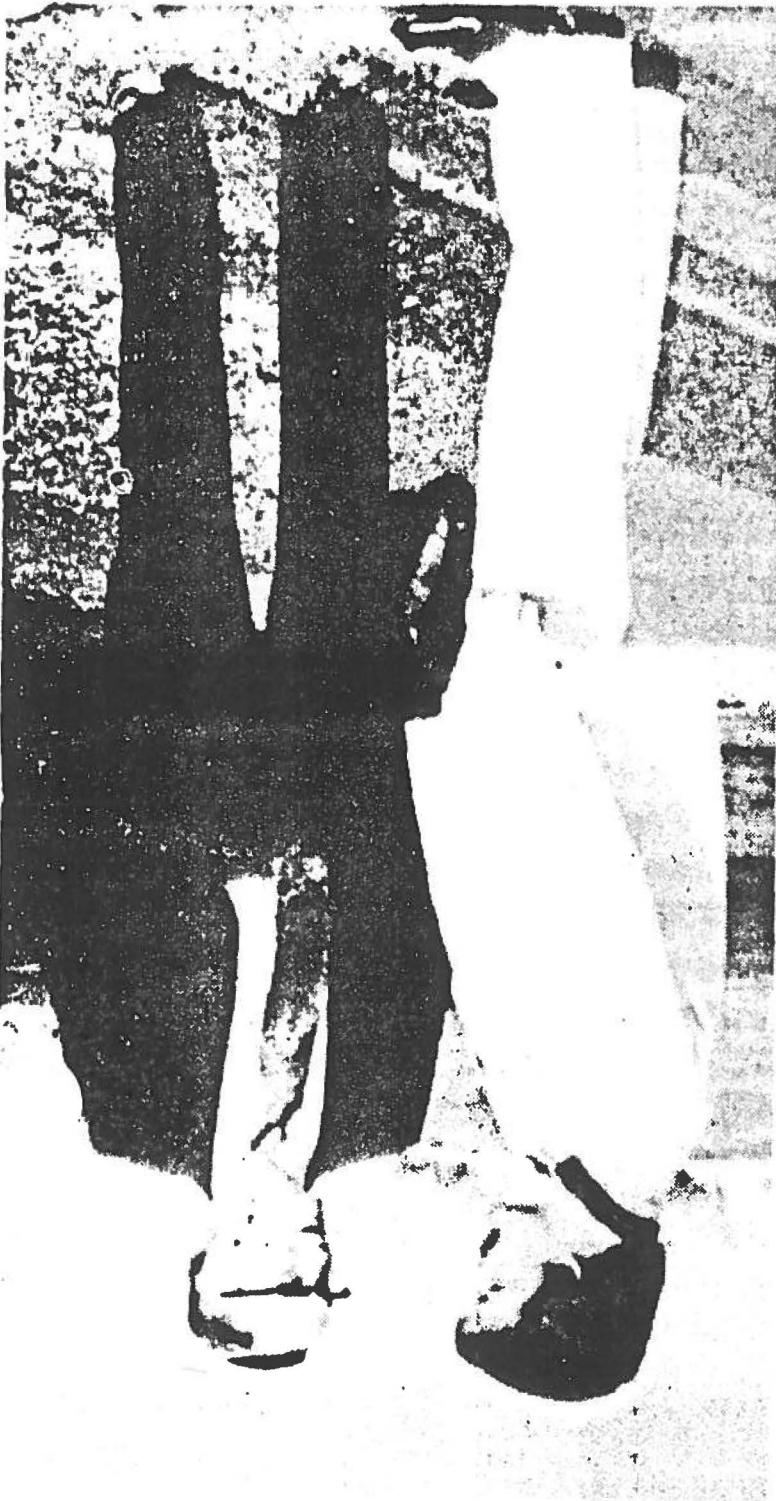

Male or Female	CHILDREN (Arrange in order of birth)	WHEN BORN (Day Month Year)	WHERE BORN (Town or Place)	State or Country	WHEN DIED (Day Month Year)	Married
M	1	John Paul			23 Sep 1943	
	2					
	3					
	4					
	5					
	6					
	7					
	8					
	9					
	10					
	11					
	12					
	13					

HUSBAND'S NAME John Fawcett

WIFE'S MAIDEN NAME Edith L. Courts

When Born _____ Where _____
 Christened _____ Where _____
 When Died _____ Where _____
 When Buried _____ Where _____
 When Married _____ Where _____
 Other Wives (if any) _____
 Number (1) (2) etc. _____

His Father _____
 His Mother's Maiden Name _____

When Born _____ Where _____
 Christened _____ Where _____
 When Died _____ Where _____
 When Buried _____ Where _____
 When Married _____ Where _____
 Other Wives (if any) _____
 Number (1) (2) etc. _____

This information obtained from _____
 6-1997 - Shannon Kilborn
 1997 - Donna Johnson
 *1997 - Peoples Com.
 *1997 - Betty Wolf

Compiler Doris Baker
 7968 Church Rd. SW
 Newcomerstown, OH 43832

Address _____
 City _____ State _____

Her Father R. Carl Courts
 Her Mother's Maiden Name Wilma Stevens

When Buried _____ Where _____
 When Died *17 Feb 1990
 Christened *Lived @ Newcomerstown
 When Born *7 May 1921

FANTIN
 COULTS

Family Group Sheet, Form 13
 © The Everton Publishing Co., 520 North Main Street, Logan, Utah
 If burial date is known on children and not death date, write
 burial date, prefix (burial) for reverse side for additional info.

13	To								
12	To								
11	To								
10	To								
9	To								
8	To								
7	To								
6	To								
5	To								
4	To								
3	To								
2	To								
1	To								

M¹ Richard F., IV
 F² Lorie Lynn

16 Apr 1964
 9 Nov 1966

Male or Female	CHILDREN (Arrange in order of birth)	WHEN BORN	WHERE BORN	WHEN DEED	Married
	Day Month Year	Town or Place	State or Country	Day Month Year	

HUSBAND'S NAME
 Richard F. Gaynor, III
 Lives in GA.

WIFE'S MAIDEN NAME
 Noreen Belzer

When Born _____ Where _____
 Christened _____ Where _____
 When Died _____ Where _____
 When Buried _____ Where _____
 When Married _____ Where _____
 Other Wives (if any) _____
 Other Husb. (if any) _____
 Number (1) (2) etc. _____

His Father Richard F. Gaynor II
 His Mother's Maiden Name Mary Gaults

Her Father _____
 Her Mother's Maiden Name _____

When Born _____ Where _____
 Christened _____ Where _____
 When Died _____ Where _____
 When Buried _____ Where _____
 When Married _____ Where _____
 Other Husb. (if any) _____
 Other Wives (if any) _____
 Number (1) (2) etc. _____

This information obtained from 1997 Joann Lehman
1997-Loants Family Bk. by Betty W.

(Husband's Full Name) GAYNOR
 (Wife's Maiden Name) BELZER

Address Louis Baker
7968 Church Rd. SW
State

City _____
 Date 1997
 Compiler _____
 Address _____
 City _____

No. 4

Date	To	Date	To	Date	To	Date	To	Date	To	Date	To	Date	To	Date	To	Date	To	Date	To	

Male or Female (Arrange in order of birth) WHEN BORN Day Month Year WHERE BORN Town or Place Country State or Country WHEN DIED Day Month Year Married

HUSBAND'S NAME
 When Born: Jeffrey Gaynor, 11 Jan 1951, lives in Rootstown.
 Christened: Where
 When Died: Where
 When Buried: Where
 When Married: Where
 Other Wives (if any):
 Number (1) (2) etc.
 His Father: Richard P. Gaynor II
 His Mother's Maiden Name: Mary Gaults

WIFE'S MAIDEN NAME
 When Born: Mary
 Christened: Where
 When Died: Where
 When Buried: Where
 Other Husb. (if any):
 Number (1) (2) etc.
 Her Father: _____
 Her Mother's Maiden Name: _____

City: Newcomerstown, OH 43032
 Address: 7366 Central Rd. SW
 Compiler: Don's Baker
 Date: 1997
 This information obtained from 1997 Journal Johnson 1997-Coutts Family Bk-by Betty W.

(Husband's Full Name) GAYNOR
 (Wife's Maiden Name)

Phyllis Child

Lorna's Children

To	Date	To	Date	To	Date	To	Date	To	Date	To	Date	To	Date	To	Date	To	Date	To	Date	To	Date	

M 1 James "Jim" Carl
7 Aug 1947

F 5 Kenny
16 Mar 1960

M 3 David Lynn
2 Sep 1951

M 4 Curtis Dean
14 Dec 1956

F 3 Carolyn Jane
31 Mar 1953

M 6 Donald

Male or Female	CHILDREN	WHEN BORN	WHEN BORN	WHEN BORN	WHEN BORN	WHEN BORN	WHEN BORN	WHEN BORN	WHEN BORN
	(Arrange in order of birth)	Day Month Year	Day Month Year	Day Month Year	Day Month Year	Day Month Year	Day Month Year	Day Month Year	Day Month Year

Her Father: Charles Angle

Other Husb. (# any) Number (1) (2) etc.

When Buried: Where

When Died: 22 Nov 2000

Christened: 1948 Grad. of N. Town H.S.

When Born: 19 Dec 1930

WIFE'S MAIDEN NAME #1 Lorna Angle

His Father: Ralph Earl Coats

Other Husb. (# any) Number (1) (2) etc.

When Married: #2 - Phyllis

When Buried: Peapack Com.

When Died: 20 Aug 1993

Christened: Pvt. US Army WWII

When Born: 4 Aug 1927

Her Mother's Maiden Name: Ethel Amore

City: Newsome, OH 43832

Address: Doris Baker 7968 Church Rd. SW

Compiler: Date 1997

When Born: Where

Christened: Where

When Died: Where

When Buried: Where

When Married: Where

Other Husb. (# any) Number (1) (2) etc.

His Father: His Mother's Maiden Name

When Buried: Where

When Died: Where

Christened: Where

When Born: Where

When Born: Where

(Husband's Full Name)

COATS

(Wife's Maiden Name)

ANGLE

This information obtained from

6-1997-James & Lorna

1997-James & Lorna

1997-James & Lorna

1997-James & Lorna

1997-James & Lorna

1997-James & Lorna

1997-James & Lorna

1997-James & Lorna

1997-James & Lorna

1997-James & Lorna

1997-James & Lorna

1997-James & Lorna

1997-James & Lorna

1997-James & Lorna

1997-James & Lorna

1997-James & Lorna

1997-James & Lorna

1997-James & Lorna

1997-James & Lorna

1997-James & Lorna

1997-James & Lorna

1997-James & Lorna

Family Group Sheet, Form 1-2
 © The Everton Publishers, 57th North Main Street, Logan, Utah
 If burial date is known on children and not death date, write burial date; prefix (burial), L.S. reverse side for additional info.

Male or Female (Arrange in order of birth)	WHEN BORN Day Month Year	WHERE BORN Town or Place County State or Country	WHEN DIED Day Month Year	Date	Date
M ¹	21 May 1968		13 Jun 1997	To	To
F ²	24 Feb 1971			To	To
M ³	24 Feb 1971			To	To
				To	To
				To	To
				To	To
				To	To
				To	To
				To	To
				To	To
				To	To
				To	To
				To	To
				To	To
				To	To

twins

HUSBAND'S NAME
 James Earl Courts
 When Born 7 Aug 1947
 Where 1968 Grad. of NC Town, H.S.
 Christened 29 Oct 1967
 When Married 29 Oct 1967
 Other Wives (if any) #2-
 Number (1) (2) etc. Gerry Courts
 His Father Ellen Hursley
 When Born 27 Jul 1947
 Where
 Christened
 When Died
 Where
 When Buried
 Other Husb. (if any) #1-
 Number (1) (2) etc. Her Mother's Maiden Name
 Mary Jane Wynne
 City Newcomerstown, OH 43832
 Address 7968 Church Rd. SW
 Compiler Dens Baker
 Date 4-1997

WIFE'S MAIDEN NAME
 Angela Courts
 When Born 6-1977
 Where
 Christened
 When Married 1-7-1998
 Other Wives (if any) #1-
 Number (1) (2) etc. Shannon Wynne
 This information obtained from
 6-1997 Shannon Wynne
 1-7-1998 (Shannon) Ok.

(Husband's Full Name)
 COURTS

(Wife's Maiden Name)
 HURSEY

Married

In memory of Kevin

at Christmas
 Key,
 We did not write this, but it cer-
 tainly sums up how your Dad and I

My Precious Gift

Lord, the precious of all gifts
 which you have given us was our
 son's birth and life you had given
 him to be with us. Being a mother
 and father is the most precious time
 even if it sometimes is shortened.
 We remember the first time we
 unwrapped our precious bundle's
 blanket and cuddled and held. That
 love is a tremendous feeling. A
 mother and father unwraps so many
 feelings as the years go by and even
 now that you've taken Your pre-
 cious gift back, we unwrap our
 hearts daily with all our memories
 that will always be the most precious
 gift anyone could receive from You.
 His life has been and always will
 be like a video playing in our minds
 and hearts daily. Lord, it's just so
 hard understanding, but we know
 birth and life is but a gift and death
 and life after is a treasure waiting.
 Take care of our treasure, for we
 know You will. We know he is our
 crown when we wrap our arms ar-
 ound our treasure one day — isn't he
 sparkle with a blush, give him a kiss
 from Mom and Dad in front of
 everyone and tell him Mom and Dad
 misses him and loves him so very
 very much and let our jewel shine!
 Forever love,
 Mom and Dad
 (By Carla Budrow)



Dec. 24, 1997

**KEVIN COUTTS
 IN MEMORIAM**

Kathy S. Coutts

Kathy S. Coutts, 45, of 10877
 Williams Rd., Gnadenhuetten,
 O., died Saturday, Oct. 27, 2001,
 of Buckhorn Village, formerly
 of 253 E. Canal St., Newcomer-
 stown, died Wednesday night,
 Nov. 22, in Union Hospital,
 Dover.

Lozna was born in Plainfield
 on Dec. 19, 1930, a daughter of
 the late Charles E. and Ethel F.
 Amore Angie.

She was a graduate of New-
 Valley High School Class of
 1975. She worked as a dietary
 aide at Riverside Manor Nurs-
 ing & Rehabilitation Center of
 Newcomerstown. She was a
 member of St. Paul United
 Church of Christ of Port Wash-
 ington and was a 4H adviser
 for six years for the Buckhorn
 comerstown, for 11 years.

Lozna was a member of St.
 Paul Lutheran Church and an
 affiliate member of First Pres-
 byterian Church at Newcomer-
 stown. With First Presbyterian
 Church, she served as an elder,
 a session member, and be-
 longed to the women's Patricia
 Circle and the Presbyterian
 women's organization.

Lozna also belonged to the
 women's Bingo Club and en-
 joyed sewing and piano playing
 as her favorite leisure activities.

In addition to her parents,
 Lozna was preceded in death
 by a grandson, Kevin V. Coutts
 Oct. 31, 2001, beginning at 11
 a.m. with Rev. William C. Hag-
 gis II officiating. Burial will be
 in Union Cemetery, Salem
 Township, Port Washington, O.

L. Coutts of Gnadenhuetten, who
 died in 1984; a sister, Lorena J.
 Hart of Dennison, and two
 brothers-in-law, George Dilly of
 Indiana and Roy Ball of Ken-
 tucky.

Lozna is survived by three
 sons and two daughters: James
 E. and Chris Coutts of Lower
 E. and Chis Coutts of Lower
 Burrell, Pa., Curtis D. and
 Kathy S. Coutts of Gnadenhut-
 ten, and David L. and Rose M.
 Coutts, Caroline J. and Michael
 M. Tipple Sr., and Kerry L. and
 David M. Addy, all of Newcom-
 erstown. There are also 10
 grandchildren, two stepgrand-
 children, and three great-
 grandchildren. Lozna also is
 survived by a sister, Dorothy F.
 Ball of Cadiz, Ky., and a brother-
 in-law, Russell W. Hart of New-
 comerstown.

Funeral services will be held
 on Monday morning, Nov. 27, at
 11 a.m., from the Ourant Funer-
 al Home at Newcomerstown.
 Pastor William C. Haggis II will
 officiate. Burial will follow at
 Plainfield Cemetery, Coshocton
 County. Friends may call in the
 funeral home on Sunday from 2
 to 5 p.m. Memorials may be
 made in Lozna's name to the
 Rebuilding Fund, St. Paul
 Lutheran Church, 108 South
 River St., Newcomerstown, or
 the Arthritis Foundation.

Ourant
 (740) 498-6422

Kathy S. Coutts, 45, of 10877
 Williams Rd., Gnadenhuetten,
 O., died Saturday, Oct. 27, 2001,
 of Buckhorn Village, formerly
 of 253 E. Canal St., Newcomer-
 stown, died Wednesday night,
 Nov. 22, in Union Hospital,
 Dover.

Lozna was born in Plainfield
 on Dec. 19, 1930, a daughter of
 the late Charles E. and Ethel F.
 Amore Angie.

She was a graduate of New-
 Valley High School Class of
 1975. She worked as a dietary
 aide at Riverside Manor Nurs-
 ing & Rehabilitation Center of
 Newcomerstown. She was a
 member of St. Paul United
 Church of Christ of Port Wash-
 ington and was a 4H adviser
 for six years for the Buckhorn
 comerstown, for 11 years.

Lozna was a member of St.
 Paul Lutheran Church and an
 affiliate member of First Pres-
 byterian Church at Newcomer-
 stown. With First Presbyterian
 Church, she served as an elder,
 a session member, and be-
 longed to the women's Patricia
 Circle and the Presbyterian
 women's organization.

Lozna also belonged to the
 women's Bingo Club and en-
 joyed sewing and piano playing
 as her favorite leisure activities.

In addition to her parents,
 Lozna was preceded in death
 by a grandson, Kevin V. Coutts
 Oct. 31, 2001, beginning at 11
 a.m. with Rev. William C. Hag-
 gis II officiating. Burial will be
 in Union Cemetery, Salem
 Township, Port Washington, O.

L. Coutts of Gnadenhuetten, who
 died in 1984; a sister, Lorena J.
 Hart of Dennison, and two
 brothers-in-law, George Dilly of
 Indiana and Roy Ball of Ken-
 tucky.

Lozna is survived by three
 sons and two daughters: James
 E. and Chris Coutts of Lower
 E. and Chis Coutts of Lower
 Burrell, Pa., Curtis D. and
 Kathy S. Coutts of Gnadenhut-
 ten, and David L. and Rose M.
 Coutts, Caroline J. and Michael
 M. Tipple Sr., and Kerry L. and
 David M. Addy, all of Newcom-
 erstown. There are also 10
 grandchildren, two stepgrand-
 children, and three great-
 grandchildren. Lozna also is
 survived by a sister, Dorothy F.
 Ball of Cadiz, Ky., and a brother-
 in-law, Russell W. Hart of New-
 comerstown.

Funeral services will be held
 on Monday morning, Nov. 27, at
 11 a.m., from the Ourant Funer-
 al Home at Newcomerstown.
 Pastor William C. Haggis II will
 officiate. Burial will follow at
 Plainfield Cemetery, Coshocton
 County. Friends may call in the
 funeral home on Sunday from 2
 to 5 p.m. Memorials may be
 made in Lozna's name to the
 Rebuilding Fund, St. Paul
 Lutheran Church, 108 South
 River St., Newcomerstown, or
 the Arthritis Foundation.

Ourant
 (740) 498-6422

Kathy S. Coutts, 45, of 10877
 Williams Rd., Gnadenhuetten,
 O., died Saturday, Oct. 27, 2001,
 of Buckhorn Village, formerly
 of 253 E. Canal St., Newcomer-
 stown, died Wednesday night,
 Nov. 22, in Union Hospital,
 Dover.

Lozna was born in Plainfield
 on Dec. 19, 1930, a daughter of
 the late Charles E. and Ethel F.
 Amore Angie.

She was a graduate of New-
 Valley High School Class of
 1975. She worked as a dietary
 aide at Riverside Manor Nurs-
 ing & Rehabilitation Center of
 Newcomerstown. She was a
 member of St. Paul United
 Church of Christ of Port Wash-
 ington and was a 4H adviser
 for six years for the Buckhorn
 comerstown, for 11 years.

Lozna was a member of St.
 Paul Lutheran Church and an
 affiliate member of First Pres-
 byterian Church at Newcomer-
 stown. With First Presbyterian
 Church, she served as an elder,
 a session member, and be-
 longed to the women's Patricia
 Circle and the Presbyterian
 women's organization.

Lozna also belonged to the
 women's Bingo Club and en-
 joyed sewing and piano playing
 as her favorite leisure activities.

In addition to her parents,
 Lozna was preceded in death
 by a grandson, Kevin V. Coutts
 Oct. 31, 2001, beginning at 11
 a.m. with Rev. William C. Hag-
 gis II officiating. Burial will be
 in Union Cemetery, Salem
 Township, Port Washington, O.

L. Coutts of Gnadenhuetten, who
 died in 1984; a sister, Lorena J.
 Hart of Dennison, and two
 brothers-in-law, George Dilly of
 Indiana and Roy Ball of Ken-
 tucky.

Lozna is survived by three
 sons and two daughters: James
 E. and Chris Coutts of Lower
 E. and Chis Coutts of Lower
 Burrell, Pa., Curtis D. and
 Kathy S. Coutts of Gnadenhut-
 ten, and David L. and Rose M.
 Coutts, Caroline J. and Michael
 M. Tipple Sr., and Kerry L. and
 David M. Addy, all of Newcom-
 erstown. There are also 10
 grandchildren, two stepgrand-
 children, and three great-
 grandchildren. Lozna also is
 survived by a sister, Dorothy F.
 Ball of Cadiz, Ky., and a brother-
 in-law, Russell W. Hart of New-
 comerstown.

Funeral services will be held
 on Monday morning, Nov. 27, at
 11 a.m., from the Ourant Funer-
 al Home at Newcomerstown.
 Pastor William C. Haggis II will
 officiate. Burial will follow at
 Plainfield Cemetery, Coshocton
 County. Friends may call in the
 funeral home on Sunday from 2
 to 5 p.m. Memorials may be
 made in Lozna's name to the
 Rebuilding Fund, St. Paul
 Lutheran Church, 108 South
 River St., Newcomerstown, or
 the Arthritis Foundation.

Ourant
 (740) 498-6422

Male or Female	CHILDREN (Arrange in order of birth)	WHEN BORN Day Month Year	WHERE BORN Town or Place County State or Country	WHEN DIED Day Month Year	Married
1					
2					
3					
4					
5					
6					
7					
8					
9					
10					
11					
12					
13					

HUSBAND'S NAME
 When Born 21 May 1968 Doyer, OH
 Christened 13 Jun 1992 Newcomerstown, OH
 When Died 16 Jun 1992 Peoples Com.
 When Buried 16 Jun 1992
 When Married 6-1997 Shannon Wilson
 Other Wives (if any) Number (1) (2) etc.
 His Father James (Coutts) His Mother's Maiden Name Ellen Murray

WIFE'S MAIDEN NAME
 When Born _____ Where _____
 Christened _____ Where _____
 When Died _____ Where _____
 When Buried _____ Where _____
 Other Husb. (if any) Number (1) (2) etc.
 Her Father _____ Her Mother's Maiden Name _____

Compiler Dots Baker
 Address 7968 Church Rd. SW
 City Newcomerstown, OH 43832
 State _____

(Husband's Full Name) **COUTTS Kevin**
 (Wife's Maiden Name) _____

This information obtained from 6-1997 Shannon Wilson

Name of Compiler Doris Baker
 Address 7968 Church Rd.
 City, State Newcomerstown, OH43832
 Date 11 Jun 1998

Person No. 1 on this chart is the same person as No. _____ on chart No. _____

Ancestor Chart

b. Date of Birth
 p.b. Place of Birth
 m. Date of Marriage
 d. Date of Death
 p.d. Place of Death

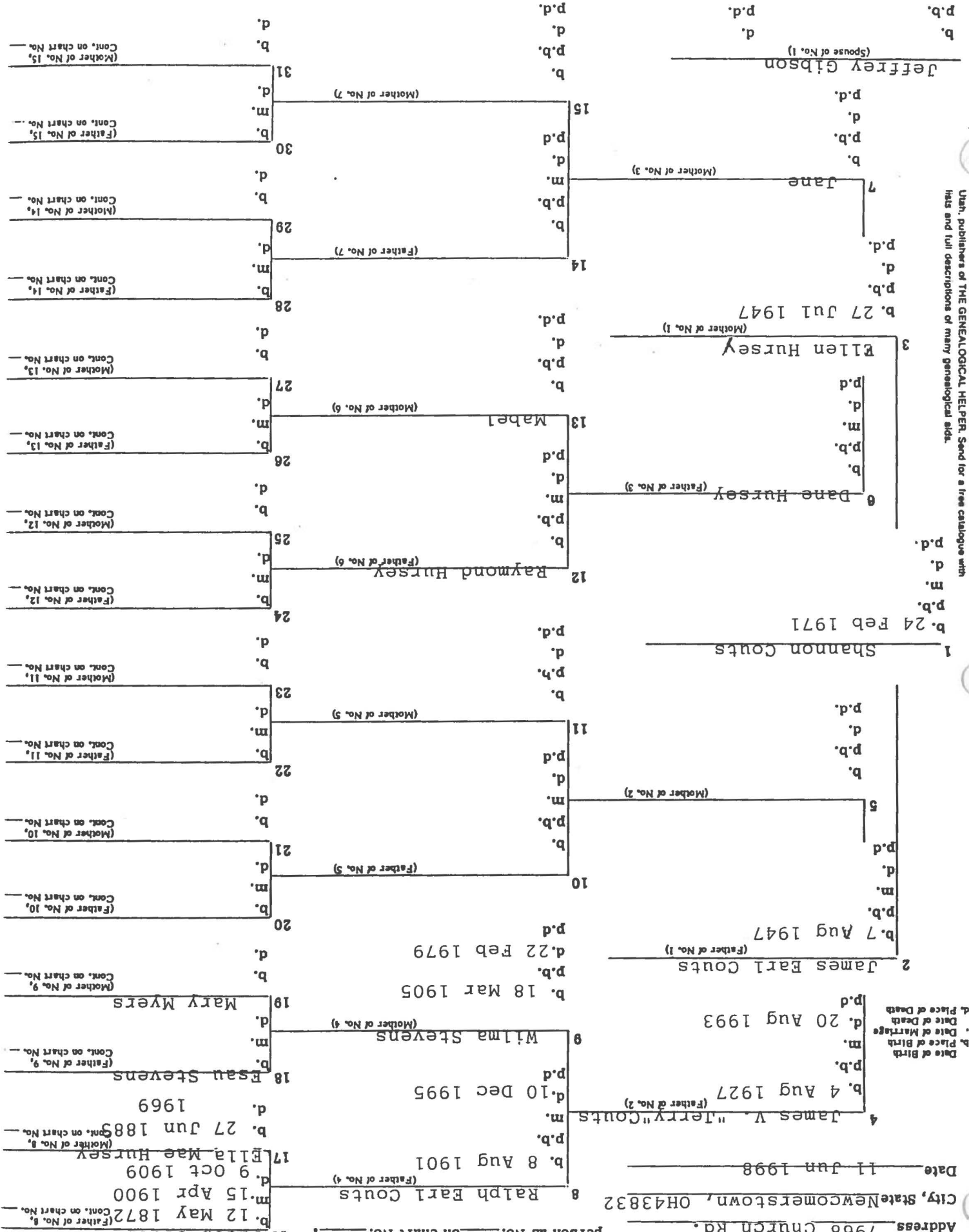

CHILDREN (Arrange in order of birth)	WHEN BORN		WHERE BORN		Date	To	Date	To	Date	To	Date	To	Date	To
	Year	Day	Month	Year										
F 1 Amber Manner	6 Feb	1991												
M 2 Austin Jeffroy	11 Jun	1994	Dover	Tas.										

Male or Female (Arrange in order of birth)
 CHILDREN (Arrange in order of birth)
 WHEN BORN Year Day Month Year
 WHERE BORN Town or Place State or County Country
 WHEN DIED Year Day Month Year
 Her Father James Earl Coats Her Mother's Maiden Name Ellen Hursley
 City Newcomerstown, OH 43832 State
 Address 7968 Church Rd. SW
 Compiler Dons Baker
 Date 4-1997
 When Buried Where
 When Died Where
 Christened Where
 When Born 24 Feb 1991 Where
 WIFE'S MAIDEN NAME Shannon Coats
 His Father David Gibson His Mother's Maiden Name Laura
 When Buried Where
 When Married Where
 Other Wives (if any) Number (1) (2) etc.
 When Born Where
 Christened Where
 When Died Where
 (Husband's Full Name) GIBSON
 (Wife's Maiden Name) COATS
 This information obtained from Birthday Announcements. Sign. 6-1997 Shannon Coats

Shannon Gibson (left) and Mike Kennedy (right) of the Newcomerstown Police Dept. flank Mr. and Mrs. John Gray, parents of Newcomerstown Policeman John Gray (rear) while presenting them with a donation. Mr. Gray was diagnosed with mouth and throat cancer last year and a fund has been set up at Bank One in Uhrichsville.

FAMILY RECEIVES DONATION

Jan. 7, 1998

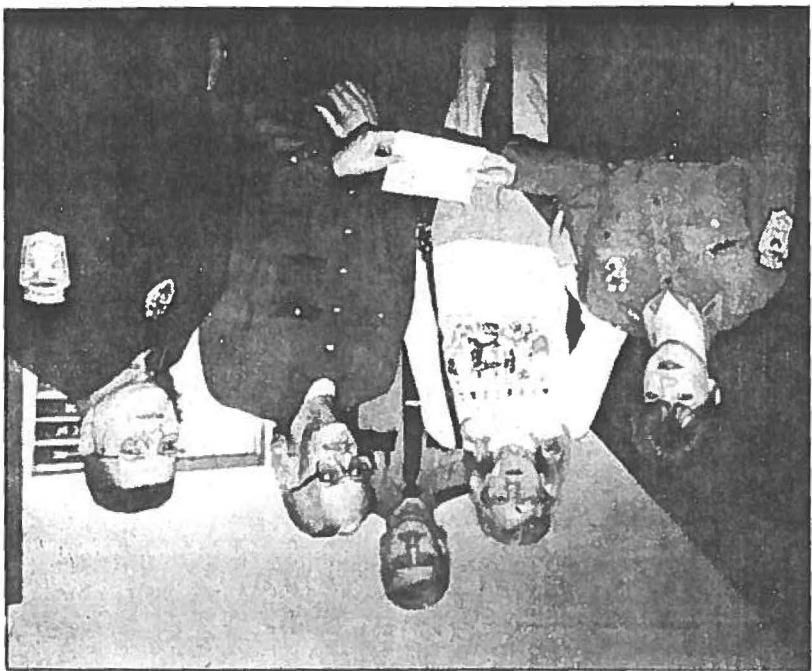

COUTS GRAVESTONES

From Tuscarawas Co., Oh - Cemetries Vol. VI - Oxford, Washington, Rush

and Perry Townships

Peoples Cemetery

p.64 - James M. Couts -d. 9 Jun 1886 36y

West Lawn Cemetery

p. 75 - Cora May Couts 21 Apr 1885 - 23 Mar 1923

Ernest Ray Couts 1889 - 1933

Hollis E. Couts 1891 - 1973

David B. Couts s/ER & HE 1913 - 1926

p. 97 - Charles E. Couts 1906 - 1973

Velma M. Couts 1909

p. 112 - James R. Couts Pvt. US Army WWII 2 Aug 1921 - 30 Jul 1982

p. 113 - Woodrow W. Couts 26 Dec 1917 - 25 May 1970

p. 114 - Ernest A. Couts 12 Sep 1881 - 24 Jul 1970

Dora L. Couts 5 Nov 1897 - 28 Nov 1997

Couts Family Cemetery

p. 154 - Cinderella Couts d/I & Arn - 2 Aug 1866 11y 16d

Cyrus Sylvester Couts d/John & Rebecca -25 Aug 1889 11y 10m 19d

Isaac Couts s/Wm. & P. -31 Mar 1843 1y 2m

James Couts - 19 Jun 1850 42y 1m 15d

Martha J. Couts w/Charles 30 May 1825 -6 Jun 1871

Mary Jane Couts d/J & A -31 May 1816 3m 21d

Charles Couts 17 Sep 1819 - 1 May 1890

Phebe Arn Couts d/I & AM -10 Oct 1853 11m 25d

Ruth Jane Couts d/Wm & P -5 Jul 1842 2y 21d

William Couts 7 Mar 1865 84y 3m 14d

Jane Couts w/Wm. - 25 Nov 1865 82y

Hartwood Cemetery

p. 159 - Samantha Couts d/ME 31 Dec 1q858 1y 7m 7d

Mary E. Couts w/Wm. V. - 9 May 1874 32y 9m 25d

Wesley Chapel Cemetery

p. 171 - Sarah A. Couts 27 Feb 1868 - 14 Aug 1949

Jasper W. Couts 18 May 1855 - 27 Jul 1925

Elizabeth Couts 1844 - 1928

Thomas N. Couts 1859-1924

George Clinton Couts 13 Nov 1860 - 7 Jul 1890

Nettie Couts 25 May 1859 - ?

John Albert Couts 28 Sep 1883 - 16 Mar 1933

Franklin P. Couts 10 Aug 1859 - 5 Nov 1932

William A. Couts 17 Sep 1844 - 9 Aug 1925

p. 172 - Isaac Couts 1817 - 1907

Amanda M. Couts w/Isaac 1824 - 1906

p. 175 - Elizabeth Couts 10 Oct 1821 - 25 Dec 1897

Original Draft

Henry F. Coutts s/JL & AM -21 Jul 1901 18y 7m 1d
p.176 - John Iams Coutts 1850 - 1943
Army Bailey Coutts 1858 - 1932
West Union Cemetery
p. 189 - Victor S. Coutts 5 Feb 1875 - 9 Sep 1964

Johnson speaks at Memorial Day Service

NIKI REID
NEWCOMERSTOWN NEWS

Col. Ed Johnson (ret.), former-ly of Plainfield, was the guest speaker this year during the Waggoner Cemetery Memorial Day Service, May 15, held at River Greens Golf Course due to inclement weather.

"Sacrifice is meaningless unless we remember," Johnson said during his address.

He said this Memorial Day marks the 136th time it has been celebrated in the United States. He said the holiday started in 1868 as Decoration Day when it was used as a way for Civil War soldiers' graves to be decorated. Throughout the history of the United States, Johnson said more than three million Americans have lost their lives in conflicts. There are even 11 Civil War veterans buried in Waggoner Cemetery.

"We still need to remember their contributions past and present," Johnson said.

Johnson said Memorial Day is not just a holiday, it's a day to remember the ones who fought for our freedom.



Niki Reid/Newcomerstown News
Col. Ed Johnson (ret.) was the guest speaker during the Friends of the Waggoner Cemetery Memorial Day Service Saturday, May 15.

LANE GRIBBLE
Lane Curtis Gribble celebrated his fifth birthday May 16. He is the son of Bud and Shannon (Couts) Gribble.

Grandparents are Ellen Couts, Diana and Doug Thompson, and Larry and Barb Gribble, all of Newcomerstown, and Jim Couts, Pennsylvania.

Great-grandparents are Dane and Jane Hursey, Newcomerstown.

Lane has a sister, Amber, 13, and a brother, Boss, nine.



Happy Birthday

May 19, 2004

Police Sergeant says good bye to post

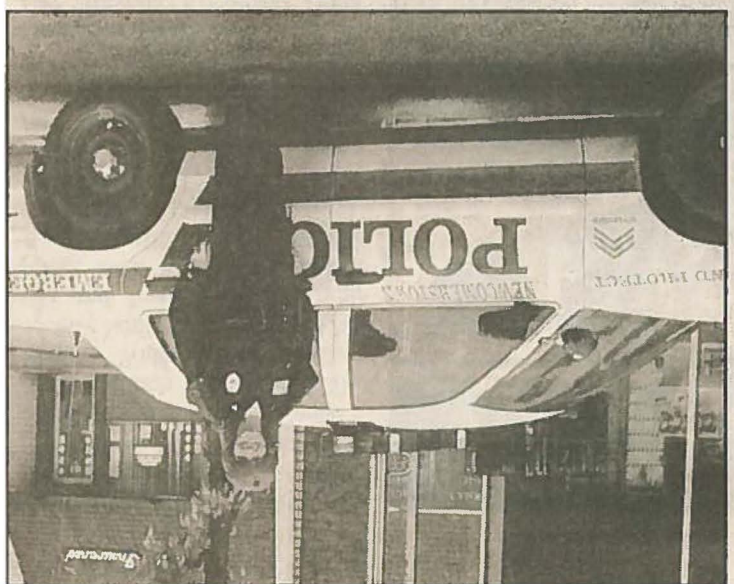

NIKI REID/NEWCOMERSTOWN NEWS
 Newcomerstown Police Sgt. Shannon Gribble stands next to her police cruiser. Gribble will be leaving her post effective May 22 as she will become a social service aide at the Tuscarawas County Job and Family Services.

NIKI REID
 NEWCOMERSTOWN NEWS

For the past seven years, Police Sgt. Shannon Gribble has been patrolling the streets of Newcomerstown but as of May 22 her duty in the community will change as she leaves her post.

"I really, really enjoyed it," Gribble said. "I like helping people. I have no regrets at all." Gribble submitted her resignation letter May 8 and her resignation is effective May 22. She will leave her post on the police department but will become a social service aide for the Tuscarawas County Job and Family Services.

Gribble began her tenure on the Newcomerstown Police Department in June 1996 as a part-time dispatcher. Then, after taking police officers training from the Ohio Police Officers Training Academy, she became a reserve officer and dispatcher. In 1999, she became a full-time road officer and in 2000 she was promoted to Sergeant.

"This was just something I wanted to do," Gribble said. "I wanted to help people." She said in her seven years of service to Newcomerstown, there were many scary moments but she said anytime when she sent an officer out on a call she was scared for them.

"It's scary anytime you send an officer somewhere," she said. "I don't want anything to happen to anyone." Recently, Gribble has been welcoming the next shift of officers when she leaves by saying "be careful."

She said she normally arrives at the police station about 6:45 in the morning and, normally, leaves at 3 p.m. But, there are times when she may work until 8 or 9 in the evening. She said that is part of the job, always being on-call.

As far as going to another police department, she said she could never do it. She said she knows everyone in this community and that is part of the reason why she became a police officer was to help those people. She said she's not sure if she'll return to her post in Newcomerstown because she lives by the idea of "never say never" and "nothing in life is guaranteed."

She said she's going to focus on her family.

"They're ready for it," Gribble said about her leaving the police department. "They're happy."

ZANESVILLE -- C.W. Parsons of Zanesville has been randomly selected as the winner of the First Federal/Auer Hardware Home Safety Kit Giveaway. As part of a promotion to increase awareness and communicate the benefits of home equity loans, First Federal created a contest that gave away a home safety kit. The kit, which was supplied by First Federal's business customer Auer Hardware, First Federal received hundreds of entries at each of its six locations in Zanesville, Coshocton, Roseville and Newcomerstown.

Safety kit giveaway winner selected

Community

THE NEWCOMERSTOWN NEWS
140 W. Main St., Newcomerstown, Ohio

May 5, 2004

West School students rewarded for reading



Erin Burtler, a student at West School, gets ready to throw a pie at West School teacher Angela Couts at their Accelerated Reader celebration April 23.

West School students were challenged at the beginning of the school year to earn 25,000 Accelerated Reader points. Students reached that goal and a school-wide celebration was held April 23. The high school jazz band led West School students through West School and outside to the blacktop. Students were then treated to some lively tunes and some terrific dance moves by Mrs. Hamersley and several students. Mrs. Kellish and Miss Ott also lead students in reading cheers. Teams of teachers and students ran a series of relay races involving water balloons, wet sponges and a variety of forms

Announcement made of birth

Tom and Jody Winland, Frazeytsburg, are announcing the birth of their son, Chase Remington. He was born Easter Sunday, April 11, 2004, at Bethesda Hospital in Zanesville, and weighed eight pounds, 11 ounces. Grandparents are Linda and Larry Swingle, Philo; the late Thomas Winland of Adamsville; June and Dave Davis and Roger and Martha Paulun, all of Newcomerstown. Great-grandparents are Leona Hindle, Dresden; Jim Young, Sebring, Fla.; Martha Davis, Ottawa, Ohio, and Alice Long, Gnadenhuetten. Chase has a brother, Tommy, two-years-old.

of mobility (hopping, skipping, walking like a duck, etc). Names were drawn and several books were given away. The highlight of the event was the pie-throwing activity. Students brought in pennies to vote for the teacher that should get a pie in the face. (All proceeds go to the Cancer Society's "Relay for Life.") Students brought in a total of \$280.64. In all, six teachers received a pie. The pies were thrown by the top readers in the school.

June 16, 1999



SHAUNA COX

Little Miss Shauna Cox celebrated her first birthday June 10. Her parents are Tom and Bobbie Cox, Newcomerstown. Grandparents are Janet Coufs, Ron Huff, and June Cox, all of Newcomerstown. Her great-grandparents are Bill and Jane Coufs, and Betty and Harold Huff, all of Newcomerstown. Shauna also has two half brothers, Tom and Matt Cox.

SHANNON COUFS and BUD GRIBBLE



Shannon Coufs and Bud Gribble are announcing their engagement and July 17 wedding date to their family and friends. The bride-elect's parents are Ellen Coufs, Newcomerstown, and Jim Coufs, Pennsylvania. Her fiancé's parents are Diana Birker and Larry Gribble, both of Newcomerstown. The couple graduated from Newcomerstown High School, she in 1989 and he in 1992. She is employed with the Newcomerstown Police Department and he is self-employed.

Wedding date announced

SHANNON COUFS and BUD GRIBBLE



Shannon Coufs and Bud Gribble are announcing their engagement and July 17 wedding date to their family and friends. The bride-elect's parents are Ellen Coufs, Newcomerstown, and Jim Coufs, Pennsylvania. Her fiancé's parents are Diana Birker and Larry Gribble, both of Newcomerstown. The couple graduated from Newcomerstown High School, she in 1989 and he in 1992. She is employed with the Newcomerstown Police Department and he is self-employed.

Wedding date announced

Lane Gribble, who turned four on May 16. He is the son of Shannon and Bud Gribble, Kimbolton. Grandparents are Ellen Coufs, Diana and Doug Thompson, and Larry and Barb Gribble, all of Newcomerstown, and Jim Coufs, Pennsylvania. Great-grandparents are Dane and Jane Hursey, Newcomerstown. Lane has a 12-year-old sister, Amber, and an eight-year-old brother, Boss.



Happy 4th Birthday

May 21, 2003

July 9, 1997

★ ★ ★ Amber Marie Gibson ★ ★ ★

Roses Are Red
Violets Are Blue
You Did So Good In T-Ball
Mommy & Boss Are So
Proud of You!

Look Out, COACH-PITCH -
--HERE SHE COMES!
We Love You,
Mommy & "Boss"

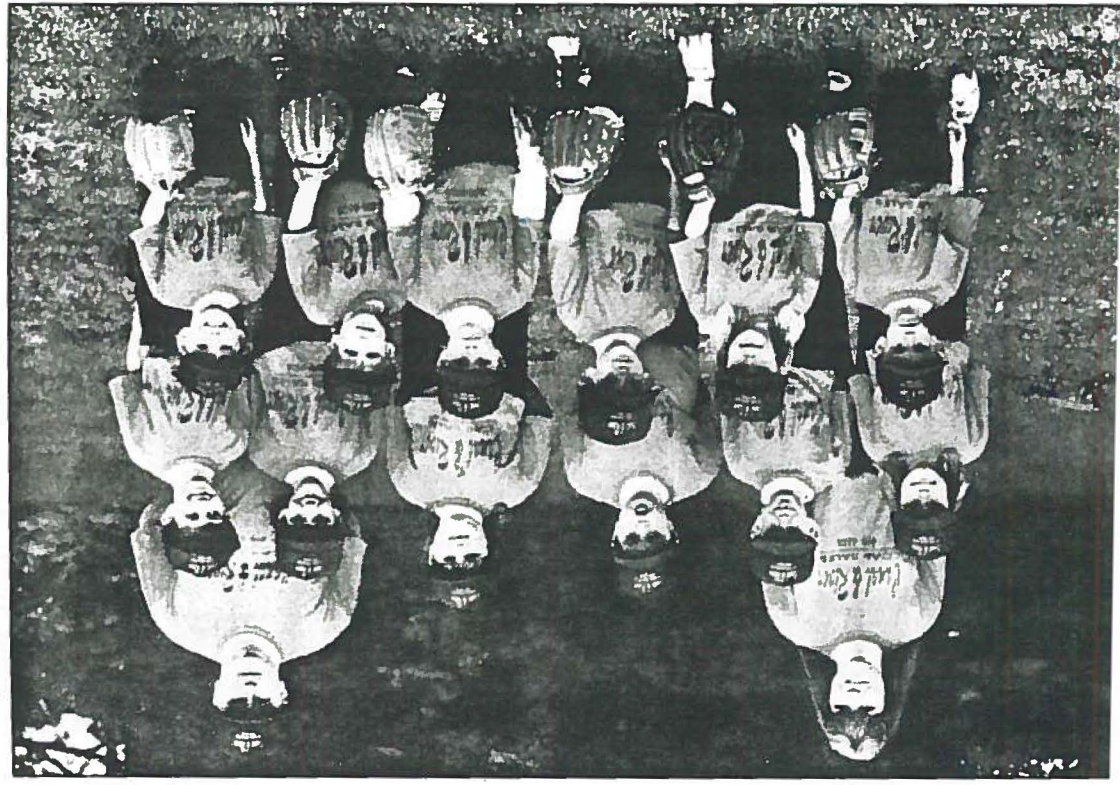
July 9, 1997

CANAL & RIVER AUTO SALES

Back (L to R): Coach Shannon Gibson, Coach Jim Gray, Middle: Amber Gibson, Scott Hannahs, Mathew Watson, Ashley Stout, Brandi Crank, John Machan. Front Row: Ethan Perkins, Sheila Gray, Dusty Daughtery, Clint Foraker, Jamie Stout, Ashley Beech.



**CANAL & RIVER
CAR SALES, INC.**

245 W. CANAL
498-4608

Times a'changing

Grandchildren following footsteps

BETH GRANT
NEWCORNERSTOWN NEWS

Shannon Gibson and Tom Couls

seem to have inherited their caring and involvement with helping people from their grandfather, Dane Hursey. This common characteristic has led the two grandchildren to follow closely in his footsteps - including a career in law enforcement. Dane served as a dispatcher on the Newcomerstown Police Department from 1967 to 1973. At that time, other dispatchers included Bill Moore and Hursey. Things were a little different then because the Fire Department was still housed in the municipal build-

ing and dispatched through the police department. "This led to some amusing incidents," said Hursey. "One night we received a call and Everett McElhaney answered the call, jumped in the fire truck and left," said Hursey. When the other firefighters arrived at the station and asked where the fire was, Hursey had no idea what the location of the fire was because McElhaney just jumped in and responded.

Today Shannon is a part-time dispatcher for the department and a reserve officer following her completion of training at the Buckeye Career Center. Although the 911 emergency response system handles fire and emergency dispatching, many of the requirements of the job remain the same. "This is something I've always wanted to do," said Gibson. "I love it. I like helping people." She also plans to take EMT classes. Another difference between the department now and in Dane's employment is the housing of prisoners. The jail formerly had five cells and could hold prisoners indefinitely. Today the jail has one holding cell and a dormitory which can hold three people, but they are only held until transfer to the county jail.

Tom (Shannon's twin brother) is employed with the Coshoccon County Sheriff's Department as a full-time deputy working in the corrections division. He is continuing the family tradition of wanting to help people, although he says they don't always appreciate his help. "Probably the worst part of the job is that I could go out tonight and save someone's life and they'll be the first to criticize my actions," said Couls.

Dane echoes the sentiment that the police department always seems to be heard about in a negative manner. "The guys have always done a lot of good for the community, but that's not what people hear," he said. Along with size of the departments, Shannon and Tom have seen some other obvious differences between the two departments including pay and fringe benefits such as clothing allowances. According to the pair, there is at least a \$5 per hour difference in pay. Coshoccon also gives its officers \$400 more a year for clothing allowance. "Obviously, we don't do this for the money," said Gibson. All three seem to possess the characteristics that enable them to perform their duties effectively including an ability to handle multiple activities at one time when the phone is ringing, an officer is on the radio and you might have a person at the window along with a fire or emergency call. Maybe it's the sense of excitement but more likely the sense of involvement which attracts them to the position. "You keep track of what's happening and where your officers are," said Gibson. "The paperwork can always wait."

The Newcomerstown Department is currently installing and receiving training for a computerized system of operations following the receipt of a grant. "We may actually be one of the first in this area to have this equipment," said Gibson. If you were going to look for an inheritance to leave your family, perhaps the contributions of their grandfather to encourage caring and involvement in the community are his greatest legacy.

Hospitals

Union

ADMISSIONS

Dover - Valerie Hostetler, Evelyn Newton.

New Philadelphia - Kaylee Arthur, Joan Hizer, Dorothy Litg.

Elsewhere - Ronald Leggett,

Sherrodsville; Nancy Steiner, Port

DISMISSALS

New Philadelphia - Alexander

Antonelli, Shirley Sayre.

Elsewhere - Ernest Eash,

Strasburg; Shannon Coult Gibson

and son, Newcomertown; Mrs.

Rick Gilbert and son, Sugarcreek;

Susan Neiminger and son, April

BIRTH

Pinchek, Uhrichsville.

Erin and Richard Gilbert, 2291

Ragersville Rd., Sugarcreek, son.

May 20, 1999

A bubbly bride and groom
Angela Gray and Tom Couts were married recently and their walk from the church to their awaiting vehi-
le was framed by bubbles on a bright summer day. This part of the wedding experience is becoming more
and more creative, moving from the traditional rice or bird seed to bubbles and even butterflies.

Ray Booth/Newcomerstown News

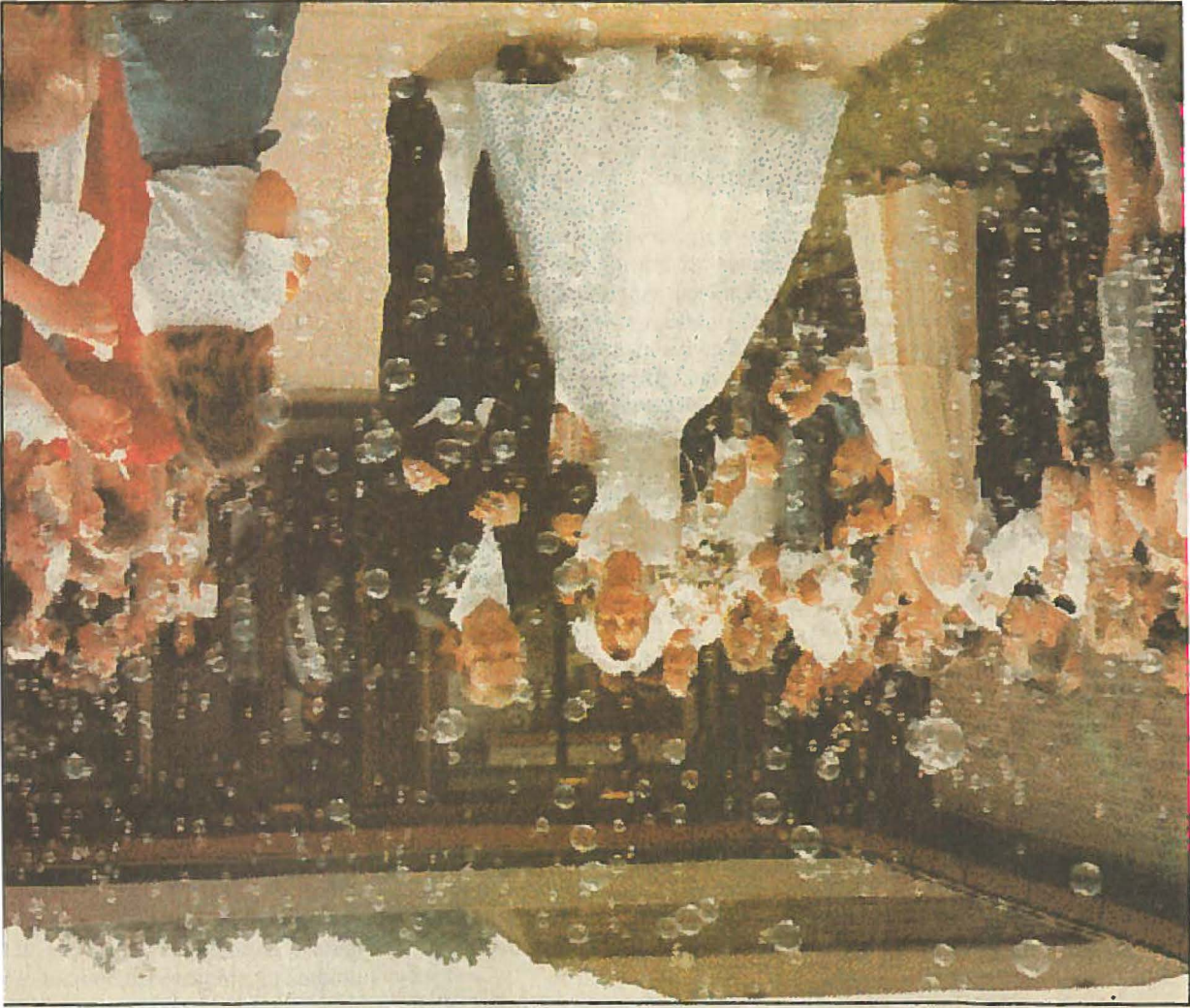

PHOTO
WEDNESDAY, JULY 29, 1998
NEWCOMERTOWN, OHIO 43832

Male or Female	CHILDREN (Arrange in order of birth)	WHEN BORN Day Month Year	WHERE BORN Town or Place	County	State or Country	WHEN DIED Day Month Year	Married
1							
2							
3							
4							
5							
6							
7							
8							
9							
10							
11							
12							
13							

HUSBAND'S NAME
 When Born _____ Where _____
 Christened _____ Where _____
 When Died _____ Where _____
 When Buried _____ Where _____
 When Married _____ Where _____
 Other Wives (if any) _____
 Number (1) (2) etc. _____
 His Father Janner Courts
 His Mother's Maiden Name Ellen Murray

WIFE'S MAIDEN NAME
 When Born _____ Where _____
 Christened _____ Where _____
 When Died _____ Where _____
 When Buried _____ Where _____
 When Married _____ Where _____
 Other Wives (if any) _____
 Number (1) (2) etc. _____
 Her Father _____
 Her Mother's Maiden Name _____

Compiler Doris Baker
 Address 7968 Church Rd. SW
 City Newcomerstown, OH 43832
 State _____

Date 1997
 This information obtained from 6-1997 Shannon Gibson

(Husband's Full Name) COURTS
 (Wife's Maiden Name) _____

Family Group Sheet, Form 1-2
 © The F. Burton Phillips, 524 North Main Street, Logan, Utah
 If burial date is known on children and not birth date, write
 burial date, prefix (BUR). Use reverse side for additional info.

Date	To	Date	To	Date	To	Date	To	Date	To	Date	To	Date	To	Date	To	Date	To

Male CHILDREN (Arrange in order of birth) _____
 or Female _____
 WHEN BORN Day Month Year _____
 WHERE BORN Town or Place _____
 County _____
 State or Country _____
 WHEN DIED Day Month Year _____
 Married _____

WIFE'S MAIDEN NAME
 Her Father _____
 Her Mother's Maiden Name _____
 Other Husb. (if any) Number (1) (2) etc. _____
 When Buried _____ Where _____
 When Died _____ Where _____
 Christened _____ Where _____
 When Born _____ Where _____

HUSBAND'S NAME
 When Born _____ Where _____
 Christened _____ Where _____
 When Died _____ Where _____
 When Married _____ Where _____
 Other Wives (if any) Number (1) (2) etc. _____
 His Father _____
 His Mother's Maiden Name _____

_____ (Husband's Full Name)
 _____ (Wife's Maiden Name)

City _____
 Address _____
 Compiler _____
 Date _____
 This information obtained from _____

COULTS
 2 Sep 1951
 1969 Grad. of Newcomerstown H.S.
 6-1997 Shannon Wilson
 1997-Coults Family Bk. by Betty W.

NOT
 married

Male or Female	CHILDREN (Arrange in order of birth)	WHEN BORN Day Month Year	WHERE BORN Town or Place	State or Country	WHEN DIED Day Month Year	Married	Date	To
M	1 Michael Monroe II	9 Apr 1981						
M	2 Flint							
F	3 Thomasina							
	4							
	5							
	6							
	7							
	8							
	9							
	10							
	11							
	12							
	13							

HUSBAND'S NAME Michael Tipple

When Born _____ Where _____

Christened _____ Where _____

When Died _____ Where _____

When Buried _____ Where _____

When Married _____ Where _____

Other Wives (if any) _____

Number (1) (2) etc. _____

His Father Glenn Tipple

His Mother's Maiden Name _____

WIFE'S MAIDEN NAME Carolyn Jane Coats

When Born _____ Where _____

Christened _____ Where _____

When Died _____ Where _____

When Buried _____ Where _____

Other Husb. (if any) _____

Number (1) (2) etc. _____

Her Father Garry Coats

Her Mother's Maiden Name Donna Angles

WHEN BORN _____ WHERE BORN _____

State or Country _____ WHEN DIED _____

Day Month Year _____

City Newcomerstown, OH 43832

Address 7968 Church Rd, SW

Compiler Doris Baker

Date 1997

This information obtained from 6-1997 Thomas Klaborn

1997 Coats Family Bk. by Betty Wolff

(Husband's Full Name) TIPPLE

(Wife's Maiden Name) COATS

Male or Female	CHILDREN (Arrange in order of birth)	WHEN BORN Day Month Year	WHERE BORN Town or Place County State or Country	WHEN DIED Day Month Year	Married
F	1 Melissa				
F	2 Bronnie				
M	3 Cody			15 May -	
	4				
	5				
	6				
	7				
	8				
	9				
	10				
	11				
	12				
	13				

HUSBAND'S NAME David Hddy

WIFE'S MAIDEN NAME Kerry Lou Coats

When Born _____ Where _____

Christened _____ Where _____

When Died _____ Where _____

When Buried _____ Where _____

When Married _____ Where _____

Other Wives (if any) _____

Number (1) (2) etc. _____

His Father _____

His Mother's Maiden Name _____

When Born _____ Where _____

Christened _____ Where _____

When Died _____ Where _____

When Buried _____ Where _____

When Married _____ Where _____

Other Wives (if any) _____

Number (1) (2) etc. _____

His Father _____

His Mother's Maiden Name _____

Husband's Full Name Addy Coats

Wife's Maiden Name (Wife's Maiden Name)

This information obtained from 6-1997 (Monroe) Wilson
 1997-Coats Family Bk. by Betty Wolf

Compiler Dons Baker
 Address 7968 Church Rd SW
 City Newcomerstown, OH 43832

Male or Female (Arrange in order of birth)	CHILDREN	WHEN BORN Day Month Year	WHERE BORN Town or Place County State or Country	WHEN DIED Day Month Year	Married
F	1	1 Aug 1952			
F	2	13 Jun 1956			
M	3	7 Oct 1962			
	4				
	5				
	6				
	7				
	8				
	9				
	10				
	11				
	12				
	13				

To Date movers married
 To Date Steve Zuzak
 To Date movers married

F 1 Sharon
 F 2 Janet
 M 3 Annal

HUSBAND'S NAME Dayne Blehman 28 Jan 1927 Where _____
 Christened _____ Where _____
 When Died _____ Where _____
 When Buried _____ Where _____
 When Married _____ Where _____
 Other Wives (if any) _____
 Number (1) (2) etc. _____

WIFE'S MAIDEN NAME Joann Coats 8 Apr 1932 Where _____
 When Born _____ Where _____
 Christened 1949 Grad. of NCTown H.S. Where _____
 When Died _____ Where _____
 When Buried _____ Where _____

Her Father Ralph Carl Coats Stover Her Mother's Maiden Name Wilma Stover
 Address 7968 Church Rd. SW Newcomerstown, OH 43832
 City Stover State _____
 Compiler Doris Baker
 Date 4-1997

(Husband's Full Name) LEHMAN
(Wife's Maiden Name) COATS
 This information obtained from 1994-Joann Baker

His Father Carl Lehman His Mother's Maiden Name Janice Stover

CHILDREN	Male or Female (Arrange in order of birth)	WHEN BORN	WHERE BORN	WHEN DIED	Married
Day Month Year	State or Country	Town or Place	Day Month Year	Day Month Year	Year
M 1	♂	23 Jul 1982	Cambridge, Mass. OH		
F 2	♀	18 Mar 1989	Cambridge, Mass. OH		
3					
4					
5					
6					
7					
8					
9					
10					
11					
12					
13					

HUSBAND'S NAME Steve Bush
 When Born 21 Jun 1955
 Christened 1973 Grad. of NCTown H.S. where

WIFE'S MAIDEN NAME Janet Lehman
 When Born 13 Jun 1956
 Christened- 1974 grad. of NCTown H.S. where
 When Died where
 When Buried where
 Other Husb. (if any) Number (1) (2) etc.
 Her Father Rayne Johnson
 Her Mother's Maiden Name Joann Costa
 City Newcomertown, OH 43832 State
 Address 7968 Church Rd. SW
 Compiler Dots Baker
 Date 4-1997

HUSBAND'S NAME Steve Bush
 When Born 21 Jun 1955
 Christened 1973 Grad. of NCTown H.S. where
 When Died where
 When Buried where
 Other Wives (if any) Number (1) (2) etc.
 His Father William Bush
 His Mother's Maiden Name Emma Fountain

(Husband's Full Name) BUSH
(Wife's Maiden Name) LEHMAN
 This information obtained from Janet Bush - 1994

See

Male or Female	CHILDREN (Arrange in order of birth)	Day Month Year	WHERE BORN Town or Place Country	State or Country	Day Month Year	WHEN DIED	Married
M	1	27 Jul 1956			27 Jul 1977		x Fam Rise 31 Jul 1977
F	2	6 Apr 1961					
F	3	27 Nov 1957					
M	4	2 Oct 1957			2 Oct 1977		x Sandra Neighbor 2 Oct 1977
	5						
	6						
	7						
	8						
	9						
	10						
	11						
	12						
	13						

HUSBAND'S NAME Raymond Green x 26 Feb 1936

When Born _____ Where _____

Christened _____ Where _____

When Died _____ Where _____

When Buried _____ Where _____

When Married x 3 Jul 1955 _____ Where _____

Other Wives (if any) _____

Number (1) (2) etc. _____

His Father Roy Green

His Mother's Maiden Name Beatha Capron

WIFE'S MAIDEN NAME Bonnie Courts x 15 Feb 1937

When Born _____ Where _____

Christened _____ Where _____

When Died _____ Where _____

When Buried _____ Where _____

When Buried _____ Where _____

Other Husb. (if any) _____

Number (1) (2) etc. _____

Her Father R. Carl Courts

Her Mother's Maiden Name Wilma Stearns

Address 7968 Church Rd SW Newcomertown, OH 43832

City _____

Compiler Bens Baker

Date 1997

GREEN
 (Husband's Full Name)
 COURTS
 (Wife's Maiden Name)

This information obtained from 6-1997 Shannon Johnson & 1997 Joann Johnson

x 1997 Joann Johnson
 x 1997 Courts Family Bk. by Betty Wolf

CHILDRN Male or Female (Arrange in order of birth)	WHEN BORN Day Month Year	WHEN BORN Town or Place	State or Country	WHEN DIED Day Month Year	Married
M ¹ Joshua					
F ² Somer Marie	8 Apr 1978				

HUSBAND'S NAME
 Michael Ray Green
 When Born: 27 Jul 1956
 Where: _____
 Christened: _____
 Where: _____
 When Died: _____
 Where: _____
 When Buried: _____
 Where: _____
 When Married: 27 Jul 1977
 Where: _____
 Other Mates (if any): _____
 Number (1) (2) etc.: _____
 His Father: Raymond Green
 His Mother's Maiden Name: Bonnie Coutts

WIFE'S MAIDEN NAME
 Pam Kise
 When Born: _____
 Where: _____
 Christened: _____
 Where: _____
 When Died: _____
 Where: _____
 When Buried: _____
 Where: _____
 Other Husb. (if any): _____
 Number (1) (2) etc.: _____
 Her Father: _____
 Her Mother's Maiden Name: _____

Compiler: Doris Baker
Address: 7968 Church Rd. SW
 Newcomertown, OH 43832
State: _____
City: _____

Date: 1997
 This information obtained from 1997-Coutts Family Bk. by Betty Wais

(Husband's Full Name): GREEN
(Wife's Maiden Name): KISE

Male or Female (Arrange in order of birth)	WHEN BORN Day Month Year	WHERE BORN Town or Place	State or Country	WHEN DIED Day Month Year	Married
F 1					
F 2					
F 3					
4					
5					
6					
7					
8					
9					
10					
11					
12					
13					

HUSBAND'S NAME Lloyd Raymond Courts
 When Born 11 Apr 1906
 Christened Where
 When Died 20 Apr 1984
 When Buried Where
 When Married 20 Oct 1934
 Other Wives (if any) Number (1) (2) etc.
 His Father Jacob Courts
 His Mother's Maiden Name Ella Mae Shumway
WIFE'S MAIDEN NAME Edna Black
 When Born 10 Feb 1915
 Christened Where
 When Died 22 Sep 1988
 When Buried Where
 Other Husb. (if any) Number (1) (2) etc.
 Her Father Orville S. Black
 Her Mother's Maiden Name *Freda Hill
 City Newcomertown, OH 43892
 Address 7968 Church Rd. SW
 Compiler Dons Baker
 Date 4-1997
 This information obtained from Mrs. Chadwell Family - TAG; Courts Family Bk. - by Betty Wolff Xdmar Courts obit.
 (Husband's Full Name) BL BGR
 (Wife's Maiden Name) COURTS

Edna M. Coutts

Edna M. Coutts, 73, of 309 Neighbor St., Newcomerstown died Sept. 22, 1988, at Coshoccon Memorial Hospital following an apparent heart attack.

She was born Feb. 10, 1915, in Guernsey County, daughter of the late Orville S. and Freda Hill Black. She was a former secretary of the Newcomerstown Chamber of Commerce, a member of the First Baptist Church and the Alma Noble Circle.

She married Lloyd Couss on Oct. 20, 1934. He died April 20, 1984. Two grandchildren are also deceased.

She leaves three daughters, Shirley Foraker of Newcomerstown R.D. 1, Mrs. Ronald (Mavis) Bonnell of Lima, and Mrs. Carl (Karen) Smith of Newcomerstown; a sister, Mrs. Ambrose (Irene) McDevitt of Coshoccon; 10 grandchildren; and six great-grandchildren.

Services were Sept. 26 at Addy Funeral Home in Newcomerstown with the Rev. Bruce Weaver officiating. Burial was in West Lawn Cemetery. Memorial contributions could be made to the Arthritis Foundation, Stark County Unit, 125 Dartmouth S.W., Canton, OH 44710.

Family Group Sheet, Form 1-72
 © The Everton Publishers, 526 North Main Street, Logan, Utah
 If burial date is known on children and you wish date, write
 burial date, prefix (bur). Use reverse side for additional info.

Male CHILDREN (Arrange in order of birth)	WHEN BORN Day Month Year	WHERE BORN Town or Place State or Country	Date To
M 1 Steve	10-5 May 1953		1 Apr 1960
F 2 Susan	4 Jul 1954		
F 3 Sheryl	25 Sep 1961		
F 4 Jacqueline	20 Feb 1963		
M 5 Clint Patterson	20 Nov 1965		

Female	WHEN BORN Day Month Year	WHERE BORN Town or Place State or Country	Date To
M 1 David Hogue			
To Randy Garretson			
To Sherry Baker - div.			

Male CHILDREN (Arrange in order of birth) WHEN BORN Day Month Year WHERE BORN Town or Place State or Country Date To

HUSBAND'S NAME Jack Foraker

When Born _____ Where _____

Christened 1953 Grad. of Newtown H.S. Where _____

When Died _____ Where _____

When Buried _____ Where _____

When Married _____ Where _____

Other Wives (if any) _____

Number (1) (2) etc. _____

His Father _____

His Mother's Maiden Name _____

WIFE'S MAIDEN NAME Shirley Gouts

When Born _____ Where _____

Christened _____ Where _____

When Died _____ Where _____

When Buried _____ Where _____

When Married _____ Where _____

Other Husb. (if any) _____

Number (1) (2) etc. _____

Her Father Lloyd Gouts

Her Mother's Maiden Name Edna Black

City _____

Address 7968 Church Rd. SW
Newcomertown, OH 43092

Compiler Doris Baker

Date 1997

This information obtained from 1997-Gouts Family Bk. - by Betty Wal 1997-Sheryl Hogue

(Husband's Full Name) FORAKER

(Wife's Maiden Name) GOUTS

Her Father Lloyd Gouts

Her Mother's Maiden Name Edna Black

City _____

Address 7968 Church Rd. SW
Newcomertown, OH 43092

Compiler Doris Baker

Date 1997

This information obtained from 1997-Gouts Family Bk. - by Betty Wal 1997-Sheryl Hogue

(Husband's Full Name) FORAKER

(Wife's Maiden Name) GOUTS

Family Group Sheet, Form 12
 © The Everton Publishers, 570 North Main Street, Logan, Utah
 If burial date is known on children and not adult date, write
 burial date, prefix (burial) or reverse side for additional info.

Male or Female	CHILDREN (Arrange in order of birth)	WHEN BORN Day Month Year	WHERE BORN Town or Place	Country	Date of Day Month Year	WHEN DIED Day Month Year	Married
	1						
	2						
	3						
	4						
	5						
	6						
	7						
	8						
	9						
	10						
	11						
	12						
	13						

HUSBAND'S NAME
 When Born 1 or 5 May 1953 where where
 Christened 1 Apr 1960 where where
 When Died 1 Apr 1960 where where
 When Buried where where where
 When Married where where where
 Other Wives (if any) where
 Number (1) (2) etc. where

WIFE'S MAIDEN NAME
 His Father Jack Foraker
 His Mother's Maiden Name Shirley Courts
 When Born where
 Christened where
 When Died where
 When Buried where
 When Married where
 Other Husb. (if any) where
 Number (1) (2) etc. where

His Father Jack Foraker
 Her Mother's Maiden Name Shirley Courts
 City Newcomerstown, OH 43832
 Address 7968 Church Rd. SW
 Compiler Doris Baker
 Date 1997

(Husband's Full Name) FORAKER
 (Wife's Maiden Name) FORAKER
 This information obtained from 1997-Sheryl Hogue

No
 1554c

Date	To	Date	To	Date	To	Date	To	Date	To	Date	To	Date	To	Date	To	Date	To	Date	To	

Male CHILDREN (Arrange in order of birth) _____
 Female _____
 WHEN BORN _____
 WHERE BORN _____
 WHEN DEED _____
 MARRIED _____

WIFE'S MAIDEN NAME
 Wife's Name: Susan Forker
 When Born: 4 Jul 1954
 Where: _____
 Christened: 1972 Grad. of Newtown H.S.
 Where: _____
 When Died: _____
 Where: _____
 When Buried: _____
 Other Husb. (if any): _____
 Number (1) (2) etc.: _____
 Her Father: Jack Forker
 Her Mother's Maiden Name: Shirley Gaults
 City: _____
 Address: 7968 Church Rd. SW
Newcomerskown, OH 43832
 State: _____
 Compiler: Doris Baker
 Date: 1997
 This information obtained from 1997-Sheryl Hogue

HUSBAND'S NAME
 Husband's Name: Thomas Little
 When Born: 11 Mar 1954
 Where: _____
 Christened: _____
 Where: _____
 When Died: _____
 Where: _____
 When Buried: _____
 Other Wives (if any): _____
 Number (1) (2) etc.: _____
 His Father: _____
 His Mother's Maiden Name: _____

(Husband's Full Name) LITTLE FORAKER
 (Wife's Maiden Name)

State _____

Name of Compiler: Doris Baker
 Address: 7968 Church Rd.
 City, State: Newcomerstown, OH 43832
 Date: 10 Jun 1998

Ascensor Chart
 Person No. 1 on this chart is the same person as No. _____ on chart No. _____.

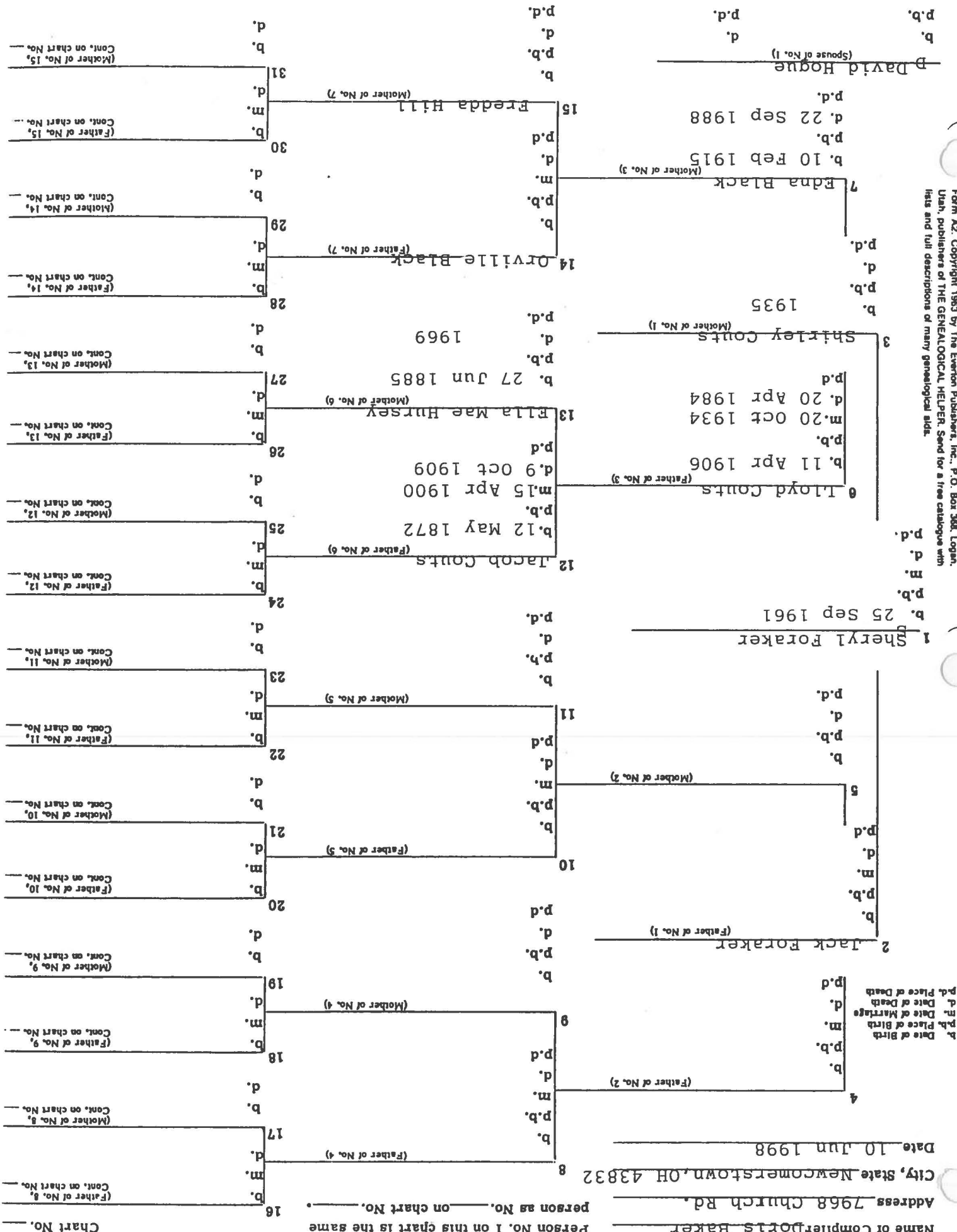

b. Date of Birth
 p.b. Place of Birth
 m. Date of Marriage
 d. Date of Death
 p.d. Place of Death

Smith Group Sheet, Form 12
 The Federal Publisher, 570 North Main Street, Logan, Utah
 If burial date is known on children and not death date, write
 burial date, prefix (bur) the reverse side for additional info.

Male or Female	CHILDREN (Arrange in order of birth)	WHEN BORN Day Month Year	WHERE BORN Town or Place County State or Country	WHEN DIED Day Month Year	Married
F	1 Anne	16 Dec 1984			
M	2 Whitney	17 Jul 1987			
F	3 Emily	14 Aug 1994			

HUSBAND'S NAME
 David Hogue
 When Born: 30 Jun 1959
 Christened: 1977 Grad. of N.Town H.S.
 When Died: Where
 When Buried: Where
 When Married: Where
 Other Lives (if any):
 Number (1) (2) etc.

WIFE'S MAIDEN NAME
 Shirley Foraker
 When Born: 25 Sep 1961
 Christened: 1980 Grad. of N.Town H.S.
 When Died: Where
 When Buried: Where
 Other Lives (if any):
 Number (1) (2) etc.

His Father: John Hogue
 His Mother's Maiden Name: Jo Ann

Her Father: Jack Foraker
 Her Mother's Maiden Name: Shirley Courts

City: _____
 Address: _____
 Compiler: Doris Baker
 7968 Church Rd. SW
 Newcomerstown, OH 43832
 State: _____
 Date: 1997

(Husband's Full Name) **HOGUE**
 (Wife's Maiden Name) **FORAKER**
 This information obtained from 1997 Shirley Hogue

Famline Group Sheet, Form 12
 The 7 version published by Sp. North Main Street, Longden, Utah
 If burial date is known on children and not death date, write
 burial date, prefix (burial) Use reverse side for additional info.

To Date	To Date	To Date	To Date	To Date	To Date	To Date	To Date	To Date	To Date	To Date	To Date	To Date	To Date	To Date	To Date	To Date	To Date	To Date
13																		
12																		
11																		
10																		
9																		
8																		
7																		
6																		
5																		
4																		
3																		
2																		

M. Clint Patterson, II 6 Sep 1991

CHILDREN (Arrange in order of birth)	Day	Month	Year	WHERE BORN	Town or Place	Country	Country	State or	WHEN DIED	Day	Month	Year	Marrried
--------------------------------------	-----	-------	------	------------	---------------	---------	---------	----------	-----------	-----	-------	------	----------

HUSBAND'S NAME
 Clint Patterson Foraker div.
 When Born 20 Nov 1965
 Christened 1984 Grad. of NCTown H.S. Where

WIFE'S MAIDEN NAME
 Sherry Baker
 When Born _____ Where _____
 Christened 1986 - Grad. of NCTown H.S. Where _____
 When Died _____ Where _____

When Buried _____
 Other Wives (if any) _____
 Number (1) (2) etc. _____

His Father
 Jack Foraker
 His Mother's Maiden Name Shirley Gouts

Her Father
 Donald L. Baker
 Her Mother's Maiden Name Judy

When Married _____
 When Buried _____
 This information obtained from 1997 - Sherry Hogue

(Husband's Full Name)
 FORAKER

(Wife's Maiden Name)
 BAKER

Compiler Doris Baker
 7908 Church Rd. SW
 Newcomerstown, OH 43832
 Address _____
 City _____
 State _____
 Date 1997

July 9, 1997

CANAL & RIVER AUTO SALES

Back (L to R): Coach Shannon Gibson, Coach Jim Gray, Middle: Amber Gibson, Scott Hannahs, Mathew Watson, Ashley Stout, Brandi Crank, John Machan, Front Row: Ethan Perkins, Sheila Gray, Dusty Daughtery, Clint Foraker, Jamie Stout, Ashley Beech.



**CANAL & RIVER
CAR SALES, INC.**

498-4608

245 W. CANAL

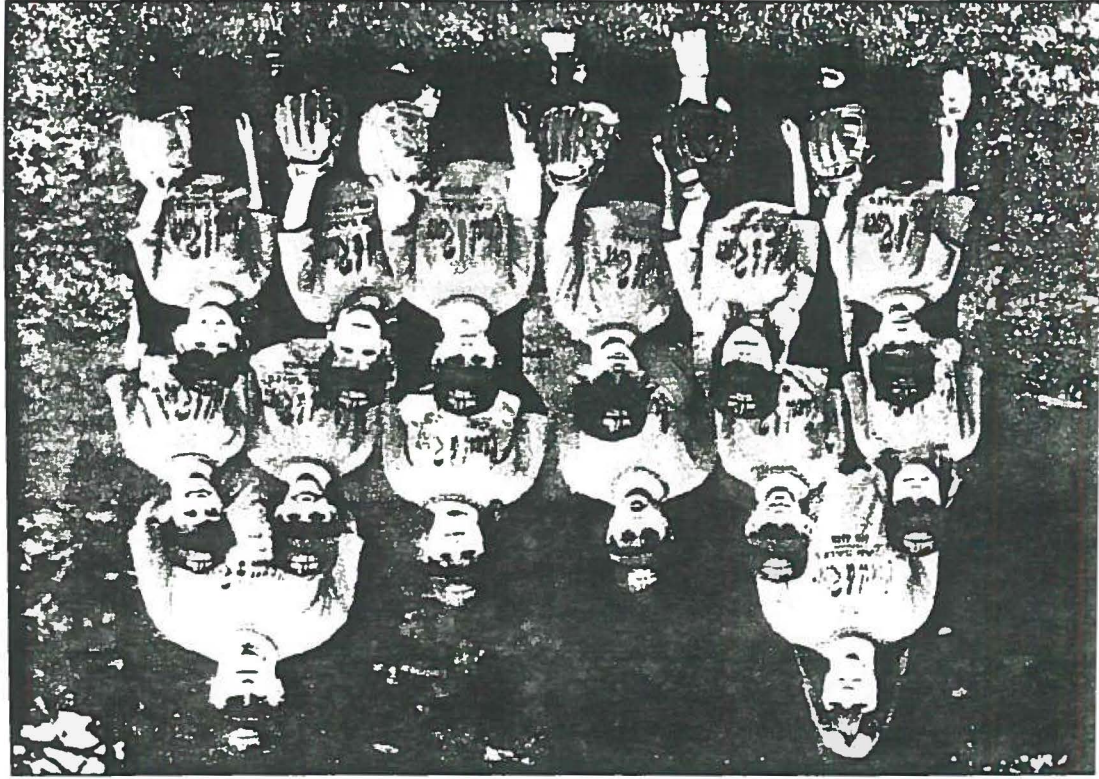

Family Group Sheet, Form 1-2
 © The Everton Publishers, 526 North Main Street, Logan, Utah
 If burial date is known on children and not death date, write burial date, prefix (bur) for reverse side for additional info.

Male or Female	CHILDREN (Arrange in order of birth)	WHEN BORN (Day Month Year)	WHERE BORN (Town or Place)	State or Country	WHEN DIED (Day Month Year)	Married
F	Vickie					
F	Debbie					
M	Gregory					
M	Douglas					

HUSBAND'S NAME Ronald Bonnell

When Born _____ Where _____

Christened 1954 Grad. of NCTown H.S. Where _____

When Died _____ Where _____

When Buried _____ Where _____

When Married _____ Where _____

Other Wives (if any) _____

Other Husb. (if any) _____

Number (1) (2) etc. _____

His Father _____

His Mother's Maiden Name _____

WIFE'S MAIDEN NAME Mavis "Mamie" Gaults

When Born _____ Where _____

Christened 1954 Grad. of NCTown H.S. Where _____

When Died _____ Where _____

When Buried _____ Where _____

When Married _____ Where _____

Other Husb. (if any) _____

Other Wives (if any) _____

Number (1) (2) etc. _____

Her Father _____

Her Mother's Maiden Name _____

City _____

Address _____

Compiler _____

Date 1997

1968 Church Rd. SW

Doris Baker

Newcomerstown, OH 43932

This information obtained from _____

1997-Sheryl Hogue

(Wife's Maiden Name) _____

(Husband's Full Name) _____

BONNELL

GAULTS

Smith Group Sheet, Form 12
 © The Fenton Publishers, 570 North Main Street, Logan, Utah
 If burial date is known on children and not death date, write
 burial date, prefix (bur.) to reverse side for additional info.

13
12
11
10
9
8
7
6
5
4
3
2
1

Date	To	Date	To	Date	To	Date	To	Date	To	Date	To	Date	To	Date	To	Date	To	Date	To	Date	To	Date	To
18 Jun 1952		11 Jan 1954		03 Apr 1957																			
M ¹ Ronald		M ² Richard "Rick" D.		F ³ Sally																			

HUSBAND'S NAME Clarebeth H. Hooker 14 Nov 1927

When Born: 14 Nov 1927 Where:
 Christened: Where:
 When Died: Where:
 When Buried: Where:
 When Married: Where:
 Other Wives (if any):
 Number (1) (2) etc.

His Father:
 His Mother's Maiden Name:

WIFE'S MAIDEN NAME Doris Robinson

When Born: 5 Jun 1931 Where:
 Christened: 1949 Grad. of NC Town H.S. Where:
 When Died: Where:
 When Buried: Where:
 Other Husb. (if any):
 Number (1) (2) etc.

Her Father: Robert Robinson
 Her Mother's Maiden Name: D. Charlene Coats

City: State:
 Address: Newcomertown, OH 43032
 Complete: 308 Central Rd. SW
 Date: 1997 Done By:

HUSBAND'S FULL NAME HOOKER ROBINSON
WIFE'S MAIDEN NAME (Wife's Maiden Name)
 This information obtained from 11-1997 Dawn Lehman
11-1997 Davis Hooker

CHILDREN
 (Arrange in order of birth)
 Male or Female

(Husband's Full Name) HOOKER
 (Wife's Maiden Name) ROBINSON

No
 issue.

1	To	Date								
2	To	Date								
3	To	Date								
4	To	Date								
5	To	Date								
6	To	Date								
7	To	Date								
8	To	Date								
9	To	Date								
10	To	Date								
11	To	Date								
12	To	Date								
13	To	Date								

Male CHILDREN (Arrange in order of birth)	Day Month Year	WHERE BORN Town or Place	Country	State or Country	Day Month Year	WHEN DEED Date	Married
-------------------------------------------------	----------------------	-----------------------------	---------	---------------------	----------------------	-------------------	---------

HUSBAND'S NAME
 Ronald Hooker
 When Born 18 Jun 1952
 Where
 Christened 1970 Grad of Newcomers High Sch.
 Where
 When Died
 Where
 When Buried
 Where
 When Married
 Where
 Other Wives (if any)
 Number (1) (2) etc.
 His Father Clarence H. Hooker
 His Mother's Maiden Name Doris Robinson

WIFE'S MAIDEN NAME
 Mary Armstrong
 When Born 1997
 Where
 Christened 1997 - RN @ Grant Hosp. in Columbus, OH
 Where
 When Died
 Where
 When Buried
 Where
 Other Husb. (if any)
 Number (1) (2) etc.
 Her Father
 Her Mother's Maiden Name

Compiler Boris Baker
Address 7968 Church Rd. SW
City Newcomertown, OH 43832
Date 1997
 This information obtained from 1997 - Doris Hooker
 (Wife's Maiden Name)
ARMSTRONG
 (Husband's Full Name)
HOOKER

Smith Group Sheet, Form 12
 © The Everton Publishers, 570 North Main Street, Logan, Utah
 If burial date is known on children and not death date, write
 burial date, prefix (bur) for reverse side for additional info.

Date	To						13
Date	To						12
Date	To						11
Date	To						10
Date	To						9
Date	To						8
Date	To						7
Date	To						6
Date	To						5
Date	To						4
Date	To						3
Date	To						2
Date	To				26 Nov 1976	M 1 Randy	
Date	To				23 Sep 1984	M 2 Ryan	

HUSBAND'S NAME Randy Emig

When Born _____ Where _____

Christened _____ Where _____

When Died _____ Where _____

When Buried _____ Where _____

When Married _____ Where _____

Other Wives (if any) _____

Number (1) (2) etc. _____

His Father _____

His Mother's Maiden Name _____

WIFE'S MAIDEN NAME Sally Hooker div.

When Born 23 Apr 1957 _____ Where _____

Christened 1997-Works @ Kurz-Kasch - (Office personnel) - 1975 Grad. of Newcomerstown N.S. _____ Where _____

When Died _____ Where _____

When Buried _____ Where _____

Other Husb. (if any) _____

Number (1) (2) etc. _____

Her Father _____

Her Mother's Maiden Name _____

CHILDREN (Arrange in order of birth)

Male _____

Female _____

WHEN BORN Day Month Year

WHERE BORN Town or Place Country State or Country

WHEN DIED Day Month Year

MARRIED Year

Compiler Dons Baker 7968 Church Rd. SW Newcomerstown, OH 43832

City _____ State _____

This information obtained from 11-1997 Dons Hooker (Husband's Full Name) **EMIG** (Wife's Maiden Name) **HOOKER**

Doris Baker
 7968 Church Rd, SW
 Newcomerstown, OH 43332

Address _____

City, State _____

Date 4-1997

11-1997 Addition

Date of Birth
 Place of Birth
 Date of Marriage
 Place of Death

4 William "Brooky" Gouts
 (Father of No. 2)
 b. 1847
 m. 1 May 1890
 d. 15 Apr 1900
 9 Oct 1909 or 25 May 1942

2 Jacob Gouts
 (Father of No. 1)
 b. 12 May 1872

5 Elizabeth Ross
 (Mother of No. 2)
 b. 1843

8 Ralph Earl Gouts
 b. 8 Aug 1901

6 Addison Chapman Hursey
 (Father of No. 3)
 m. 11 Jul 1859
 b. 28 Sep 1859

3 Ella Mae Hursey
 (Mother of No. 1)
 b. 27 Jun 1883

7 Amanda Caroline Hart
 (Mother of No. 5)
 b. 18 Apr 1860

15
 d. 21 Oct 1895

Wilma Stevens
 (Spouse of No. 1)
 b. 18 Mar 1905
 d. 22 Feb 1979

Ascension Chart

Person No. 1 on this chart is the same person as No. _____ on chart No. _____

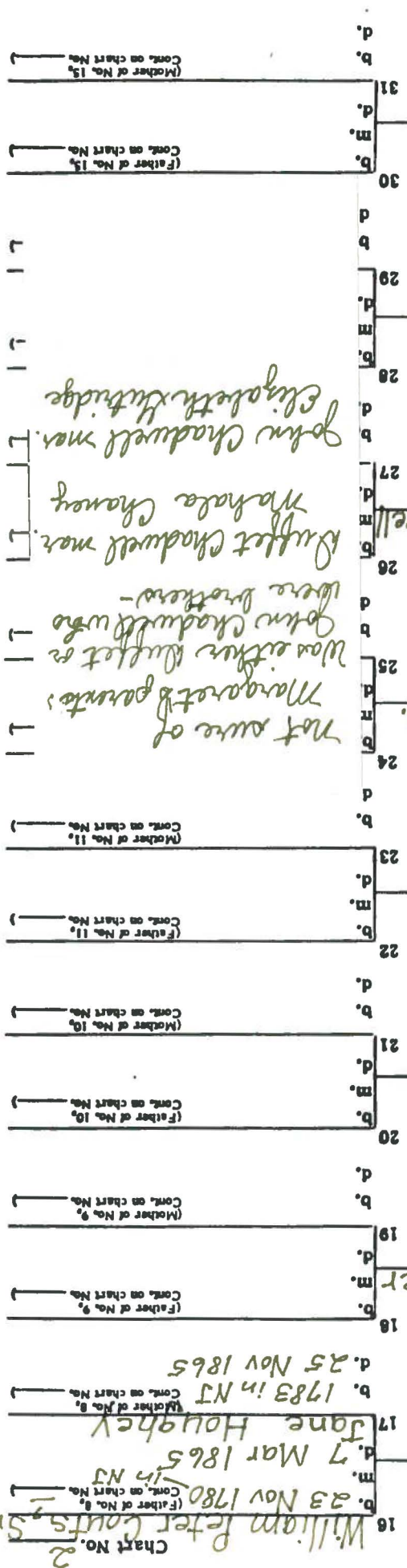

Use and full descriptions of many genealogical aids.

Use and full descriptions of many genealogical aids.

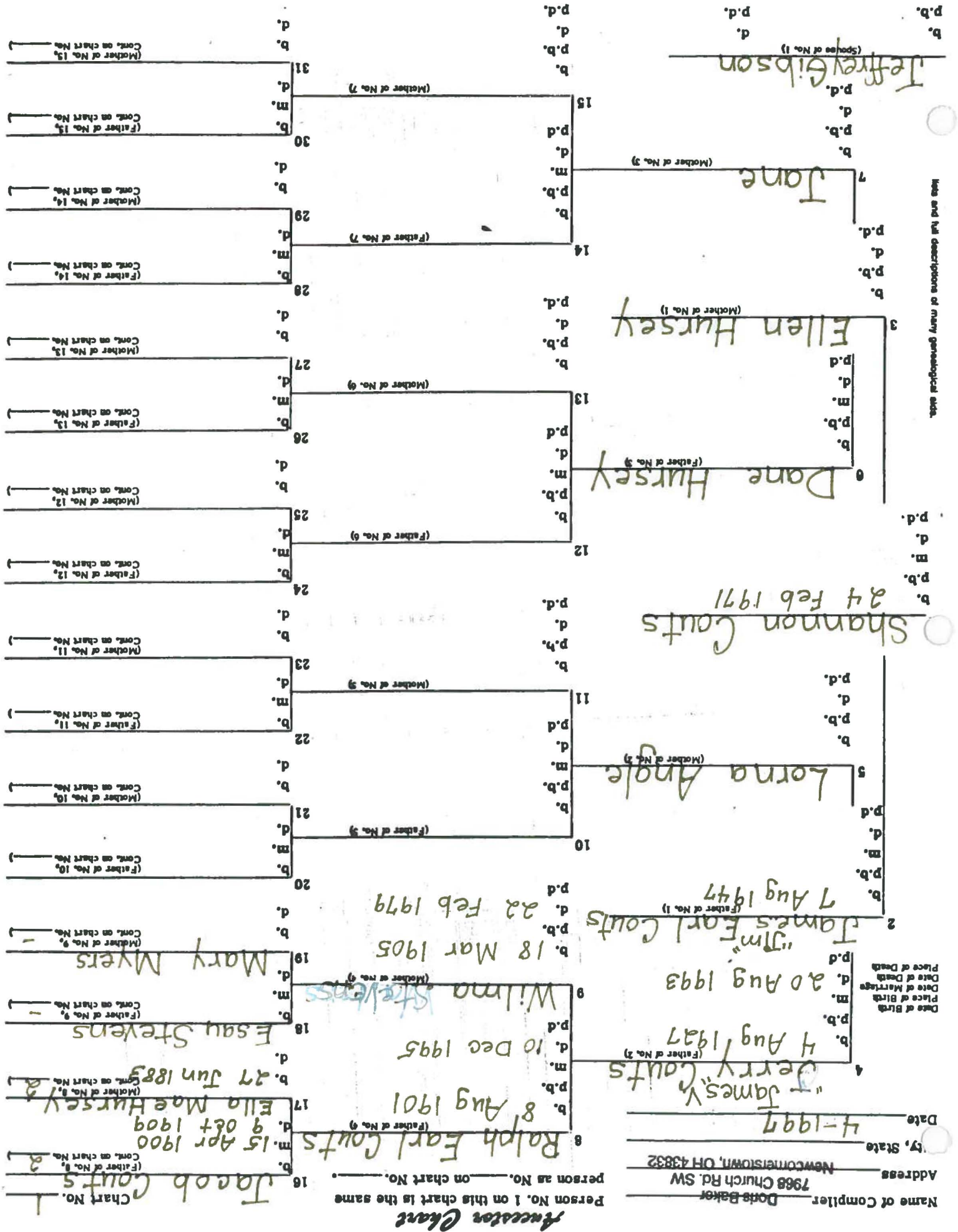

COURTS GRAVESTONES

From Tuscarawas Co., Oh - Cemeteries Vol. VI - Oxford, Washington, Rush

and Perry Townships

Peoples Cemetery

p.64 - James M. Courts - d. 9 Jun 1886 36y

West Lawn Cemetery

p. 75 - Cora May Courts 21 Apr 1885 - 23 Mar 1923

Ernest Ray Courts 1889 - 1933

Hollis E. Courts 1891 - 1973

David B. Courts s/ER & HE 1913 - 1926

p. 97 - Charles E. Courts 1906 - 1973

Velma M. Courts 1909

p. 112 - James R. Courts Pvt. US Army WWII 2 Aug 1921 - 30 Jul 1982

p. 113 - Woodrow W. Courts 26 Dec 1917 - 25 May 1970

p. 114 - Ernest A. Courts 12 Sep 1881 - 24 Jul 1970

Dora L. Courts 5 Nov 1897 - 28 Nov 1997

Courts Family Cemetery

p. 154 - Cinderella Courts d/I & Am - 2 Aug 1866 11y 16d

Cyrus Sylvester Courts d/John & Rebecca - 25 Aug 1889 11y 10m 19d

Isaac Courts s/Wm. & P. - 31 Mar 1843 1y 2m

James Courts - 19 Jun 1850 42y 1m 15d

Martha J. Courts w/Charles 30 May 1825 - 6 Jun 1871

Mary Jane Courts d/J & A - 31 May 1816 3m 21d

Charles Courts 17 Sep 1819 - 1 May 1890

Phebe Ann Courts d/I & AM - 10 Oct 1853 11m 25d

Ruth Jane Courts d/Wm & P - 5 Jul 1842 2y 21d

William Courts 7 Mar 1865 84y 3m 14d

Jane Courts w/Wm. - 25 Nov 1865 82y

Hartwood Cemetery

p. 159 - Samantha Courts d/ME 31 Dec 1q858 1y 7m 7d

Mary E. Courts w/Wm. V. - 9 May 1874 32y 9m 25d

Wesley Chapel Cemetery

p. 171 - Sarah A. Courts 27 Feb 1868 - 14 Aug 1949

Jasper W. Courts 18 May 1855 - 27 Jul 1925

Elizabeth Courts 1844 - 1928

Thomas N. Courts 1859-1924

George Clinton Courts 13 Nov 1860 - 7 Jul 1890

Nettie Courts 25 May 1859 - ?

John Albert Courts 28 Sep 1883 - 16 Mar 1933

Franklin P. Courts 10 Aug 1859 - 5 Nov 1932

William A. Courts 17 Sep 1844 - 9 Aug 1925

p. 172 - Isaac Coutts 1817 - 1907
Amanda M. Coutts w/Isaac 1824 - 1906
p. 175 - Elizabeth Coutts 10 Oct 1821 - 25 Dec 1897
Henry F. Coutts s/JL & AM -21 Jul 1901 18y 7m 1d
p.176 - John Iams Coutts 1850 - 1943
Amy Bailey Coutts 1858 - 1932
West Union Cemetery
p. 189 - Victor S. Coutts 5 Feb 1875 - 9 Sep 1964

You Did An Excellent Job This Year in Kindergarten. We Are so Proud of You. Keep Up The Good Work. We Love You. Mommy & Boss

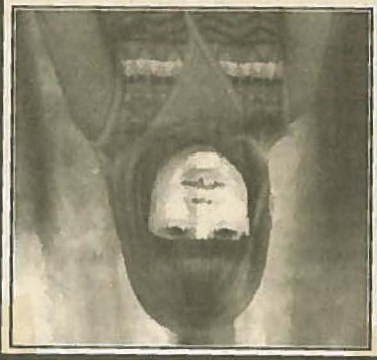

June 11, 1997

Happy birthday to Austin Jeffrey "Boss" Gibson, who will be three on June 11. He is the son of Jeff Gibson and Shannon (Couts) Gibson, both of Newcomerstown. Grandparents are Ellen Coust, Newcomerstown, and Jim Coust, and Laura and Dave Gibson, all of Pennsylvania. Great-grandparents are Jane and Dane Hursey, and Lorna Coust, all of Newcomerstown; Donna and the late Robert Schneider, South Carolina, and Lois and Gerald Gibson, Bath, O. Austin has a sister, Amber Marie, who turned six in February.

AUSTIN GIBSON



Happy Birthday

June 11, 1997

Austin Jeffrey "Boss" Gibson celebrated his second birthday Tuesday, June 11. His parents are Jeffrey and Shannon (Couts) Gibson, Newcomerstown. Grandparents are Ellen Coust, Newcomerstown, and Jim Coust, and Laura and Dave Gibson, all of Pennsylvania. Great-grandparents are Dane and Jane Hursey, and Lorna Coust, all of Newcomerstown; Robert and Donna Schneider, South Carolina, and Gerald and Lois Gibson, Ohio. Austin has a sister, Amber Marie, five-years-old.

AUSTIN GIBSON



June 12, 1996

T.C.G.S
T. Co. Obits

Randy Garretson, 27, of RD 3, Newcomerstown, was killed in a single-vehicle accident Monday night at 9:30 on Rt. 258 near Newcomerstown.

State troopers said Garretson's pickup truck went off the right edge of the road, came back across the road, went sideways and struck a tree. The accident remains under investigation.

It was the eighth traffic fatality in Tuscarawas County this year.

Arrangements are in charge of Addy Funeral Home at Newcomerstown.

Tues. Dec. 10, 1985
**Crash claims
Nc'town man**

Tues.
Dec. 10, 1985

Obituaries

R. Earl Couts

R. Earl Couts, 94, of 300 Peoli Road SW, Newcomerstown, formerly of Postboy Road, Newcomerstown, died at 10:31 a.m. on Sunday (Dec. 10, 1995) at the home of his grandson, Dave Couts.

He was born Aug. 8, 1901, at Newcomerstown, the son of the late Jacob Couts and the late Ella Hursey Couts. He was a member of Peoples Community Church and was a retired farmer and former employe at Eureka Hardware in Newcomerstown.

Mr. Couts was preceded in death by his wife, Wilma (Stevens) Couts, on Feb. 22, 1978. They had been married on Oct. 2, 1930. He was also preceded in death by a son, Jerry Couts; a daughter, Edith Fanning; and a brother and a sister.

Mr. Couts leaves three daughters, Mary Gaynor of Brunswick, Ohio, Mrs. Dayne (Joann) Lehman of Newcomerstown and Mrs. Kaymond (Bonnie) Green of West Lafayette; 17 grandchildren; 24 great-grandchildren; and five great-great-grandchildren.

Services will be at 1 p.m. Wednesday (Dec. 13, 1995) at the Addy Funeral Home in Newcomerstown with the Rev. Dwight Lyons and the Rev. Don Gilmore officiating. Burial was in Peoples Cemetery at Newcomerstown. Memorial gifts may be made to the Peoples Community Church.

John M. Mizer Sr.

John M. "Mike" Mizer Sr., 78, of 8355 Angel Valley Road, SW, Stone Creek, died Sunday (Dec. 3, 1995) in Aultman Hospital at Canton from injuries sustained in a farm accident.

He was born March 27, 1917, in Stone Creek, a son of the late Martin Luther and Irene J. Cline Mizer. A farmer, he was a 1936 graduate of Stone Creek High School and was a member of Salem-Evans Creek Lutheran Church at Stone Creek, where he taught Sunday School, was Sunday School superintendent, served on church council and sang in the choir. He was also very active in the Farm Bureau.

Mr. Mizer leaves his wife, Betty M. Neading Mizer, whom he married Nov. 19, 1946; a daughter by a previous marriage, Edna L. Mizer of West Lafayette; two daughters and sons-in-law, Linda and David Canfield of New Philadelphia and Norma and John Brink of Fresno; three sons and daughters-in-law, John M. Jr. and Margaret "Maggie" Mizer of Stone Creek, Daniel and Johanna Mizer of Fresno; and Paul and Penny Mizer of Maria Stein; 10 granddaughters; seven great-grandchildren; a sister, Erma Finner of Stone Creek; two sisters and brothers-in-law, Madeline and Frank Shutt of Walnut Creek and Verna and Charles Mutt of Stone Creek; two brothers and sisters-in-law, Chester and Mary Mizer of Bolivar and Russell and Gladys Mizer of Stone Creek; his mother-in-law, Nora Philabaum of Stone Creek; and numerous nieces and nephews.

He was preceded in death by a sister, Audrey Ott, and a brother, Carl Mizer.

Services were Wednesday at the Salem-Evans Creek Lutheran Church with Pastor J. Andrew Riggs officiating. Burial was in the church cemetery. Arrangements were handled by Linn-Hert-Geib Funeral Home in New Philadelphia. Memorial contributions may be made to Salem-Evans Creek Lutheran Church Cemetery Fund, c/o Cliff Mizer, 8915 Angel Valley Road SW, Stone Creek, OH 43840.

Lester Garretson Sr.

Lester Garretson Sr., 75, of Newcomerstown, died Sunday (Dec. 10, 1995) at Southeastern Ohio Regional Medical Center after a recent heart attack at his home. Funeral arrangements are in care of Funeral Home, Newcomerstown.

organization.

Friends may call from 7 to 9 p.m. Tuesday and from noon to 1 p.m. Wednesday at Ourant Funeral Home, Newcomerstown, where services will be in West Lawn Cemetery, Newcomerstown. Burial will be conducted by the Newcomerstown graveside services.

Lester Garretson Sr. was preceded in death by his wife, Mary Lee Dansby Russell of Columbus, and Terrell G. Russell of Newcomerstown. He was a member of St. Francis DeSales Catholic Church in the Pacific theca War II. He was a member of Thomas Montgomery Post 431, Newcomerstown, and the N.A.A.C.P. He enjoyed playing cards, and was well-known throughout Tuscarora County. He was preceded in death by two sons, Frank P. Russell, and two great-granddaughters, Jakara Harris, who died early in 1993; a grandson, Shawn Lee Russell. He leaves his wife, Mamie Lee Dansby Russell of Columbus, and a brother, Frank Russell.

He leaves his wife, Mamie Lee Dansby Russell of Columbus, and a brother, Frank Russell. He leaves his wife, Mamie Lee Dansby Russell of Columbus, and a brother, Frank Russell. He leaves his wife, Mamie Lee Dansby Russell of Columbus, and a brother, Frank Russell. He leaves his wife, Mamie Lee Dansby Russell of Columbus, and a brother, Frank Russell.

He was a U.S. Army veteran, serving in the Pacific theca War II. He was a member of St. Francis DeSales Catholic Church in the Pacific theca War II. He was a member of St. Francis DeSales Catholic Church in the Pacific theca War II. He was a member of St. Francis DeSales Catholic Church in the Pacific theca War II.

He was a member of St. Francis DeSales Catholic Church in the Pacific theca War II. He was a member of St. Francis DeSales Catholic Church in the Pacific theca War II. He was a member of St. Francis DeSales Catholic Church in the Pacific theca War II.

William R. Russell

William R. "Booker" Russell, 82, of Newcomerstown, died at 10:31 a.m. on Sunday (Dec. 10, 1995) at Mt. Carmel East Hospital, Columbus, Ohio, after a long illness.

He was born April 10, 1913, in Anniston, Ala., son of the late Adie Daper Russell.

He attended high school in both Anniston and Newcomerstown. He also attended the former Coshocton Business School. He worked for Evans Sewer and Clay, Uhrichsville, for six years. He worked for various highway projects for W.P.A. during the war. He also owned and operated the former Rusty's Inn, Newcomerstown, for several years.

He was a U.S. Army veteran, serving in the Pacific theca War II. He was a member of St. Francis DeSales Catholic Church in the Pacific theca War II. He was a member of St. Francis DeSales Catholic Church in the Pacific theca War II.

He was a member of St. Francis DeSales Catholic Church in the Pacific theca War II. He was a member of St. Francis DeSales Catholic Church in the Pacific theca War II. He was a member of St. Francis DeSales Catholic Church in the Pacific theca War II.

He was a member of St. Francis DeSales Catholic Church in the Pacific theca War II. He was a member of St. Francis DeSales Catholic Church in the Pacific theca War II. He was a member of St. Francis DeSales Catholic Church in the Pacific theca War II.

He was a member of St. Francis DeSales Catholic Church in the Pacific theca War II. He was a member of St. Francis DeSales Catholic Church in the Pacific theca War II. He was a member of St. Francis DeSales Catholic Church in the Pacific theca War II.

He was a member of St. Francis DeSales Catholic Church in the Pacific theca War II. He was a member of St. Francis DeSales Catholic Church in the Pacific theca War II. He was a member of St. Francis DeSales Catholic Church in the Pacific theca War II.

Obituaries

R. Earl Couits

R. Earl Couits, 94, of 300 Peoli Road SW, Newcomerstown, formerly of Postboy Road, Newcomerstown, died at 10:31 a.m. on Sunday (Dec. 10, 1995) at the home of his grandson, Dave Couits.

He was born Aug. 8, 1901, at Newcomerstown, the son of the late Jacob Couits and the late Ella Hursey Couits. He was a member of Peoples Community Church and was a retired farmer and former employe at Eureka Hardware in Newcomerstown.

Mr. Couits was preceded in death by his wife, Wilma (Stevens) Couits, on Feb. 22, 1978. They had been married on Oct. 2, 1920. He was also preceded in death by a son, Jerry Couits; a daughter, Edith Ferritt; and a brother and a sister.

Mr. Couits leaves three daughters, Mary Gaynor of Brunswick, Ohio, Mrs. Dayne (Joann) Lehman of Newcomerstown and Mrs. Raymond (Bonnie) Green of West Lafayette; 17 grandchildren; 24 great-grandchildren; and five great-great-grandchildren.

Services will be at 1 p.m. Wednesday (Dec. 13, 1995) at the Addy Funeral Home in Newcomerstown with the Rev. Dwight Lyons and the Rev. Don Gilmore officiating. Burial was in Peoples Cemetery at Newcomerstown. Memorial gifts may be made to the Peoples Community Church.

John M. Mizer Sr.

John M. "Mike" Mizer Sr., 78, of 8355 Angel Valley Road, SW, Stone Creek, died Sunday (Dec. 3, 1995) in Autumn Hospital at Canton from injuries sustained in a farm accident.

He was born March 27, 1917, in Stone Creek, a son of the late Martin Luther and Irene J. Cline Mizer. A farmer, he was a 1936 graduate of Stone Creek High School and was a member of Salem-Evans Creek Lutheran Church at Stone Creek, where he taught Sunday School, was Sunday School superintendent, served on church council and sang in the choir. He was also very active in the Farm Bureau.

Mr. Mizer leaves his wife, Betty M. Neading Mizer, whom he married Nov. 19, 1946; a daughter by a previous marriage, Edna L. Mizer of West Lafayette; two daughters and sons-in-law, Linda and David Canfield of New Philadelphia and Norma and John Brink of Fresno; three sons and daughters-in-law, John M. Jr. and Margaret "Maggie" Mizer of Stone Creek, Daniel and Johanna Mizer of Fresno; and Paul and Penny Mizer of Maria Stein; 10 granddaughters; seven great-grandchildren; a sister, Erma Finner of Stone Creek; two sisters and brothers-in-law, Madeline and Frank Shutt of Walnut Creek and Verna and Charles Mutt of Stone Creek; two brothers and sisters-in-law, Chester and Mary Mizer of Bolivar and Russell and Gladys Mizer of Stone Creek; his mother-in-law, Nora Philabaum of Stone Creek; and numerous nieces and nephews.

He was preceded in death by a sister, Audrey Ott, and a brother, Carl Mizer.

Services were Wednesday at the Salem-Evans Creek Lutheran Church with Pastor J. Andrew Riggs officiating. Burial was in the church cemetery. Arrangements were handled by Linn-Hert-Geib Funeral Home in New Philadelphia. Memorial contributions may be made to Salem-Evans Creek Lutheran Church Cemetery Fund, c/o Cliff Mizer, 8915 Angel Valley Road SW, Stone Creek, OH 43840.

Lester Garretson Sr.

Lester Garretson Sr., 75, of Newcomerstown, died Sunday (Dec. 10, 1995) at Southeastern Ohio Regional Medical Center after suffering heart attack at his home. Funeral arrangements are in care of Funeral Home, Newcomerstown.

organization.

Friends may call from 7 to 9 p.m. Tuesday and from noon to 1 p.m. Wednesday at Ourant Funeral Home, Newcomerstown, where services will be in West Lawn Cemetery, Newcomerstown. Burial will be conducted by the Newcomerstown graveside services.

He leaves his wife, Mamie Lee Dunsby Russell of Columbus, and four sons, William Lee, Randy A. and Terrell G. Russell of Newcomerstown, and Robert (DeLores) Nutt of Zanesville; a daughter, Adell Dean, Karen S. Thornton, and Rita Mae Dunsby; and 26 great-grandchildren.

He was a member of Thomas Montgomery Post 431, Newcomerstown, and the N.A.A.C.P. He enjoyed playing cards, rummy, and the N.A.A.C.P. He was well-known throughout the area with his family. He was preceded in death by two sons, Frank P. Russell, and two great-granddaughters, Jalara Harris, who died earlier in 1993; a grandson, Shawn Lee; and a brother, Frank Russell.

He was a U.S. Army veteran, serving in the Pacific theater during World War II. He was a member of St. Francis DeSales Catholic Church and was a member of St. Francis DeSales Catholic Church in Newcomerstown. He was a member of the former Rusty's Inn, Newcomerstown, and operated the former Rusty's Inn, Newcomerstown.

He attended high school in both Anniston and Newcomerstown. He also attended the former Coshocoon Business School. He worked for Evans Sewer and Clay, Uhrichsville, for over 20 years. He worked for various highway projects for W.P.A. during the war.

He was born April 10, 1913, in Anniston, Ala., son of the late Draper Russell.

William R. Russell

William R. "Booker" Russell, 82, of Newcomerstown, died Sunday (Dec. 9, 1995) at Mt. Carmel East Hospital, Columbus, Ohio, after a long illness.

He was born April 10, 1913, in Anniston, Ala., son of the late Draper Russell.

He was a member of St. Francis DeSales Catholic Church in Newcomerstown. He was a member of the former Rusty's Inn, Newcomerstown, and operated the former Rusty's Inn, Newcomerstown.

He was a member of St. Francis DeSales Catholic Church in Newcomerstown. He was a member of the former Rusty's Inn, Newcomerstown, and operated the former Rusty's Inn, Newcomerstown.

He was a member of St. Francis DeSales Catholic Church in Newcomerstown. He was a member of the former Rusty's Inn, Newcomerstown, and operated the former Rusty's Inn, Newcomerstown.

Raymond
Thomas

John?
Edith Franklin

"Jerry"
James V.
Aug. 4, 1927
Aug. 20, 1933
W.V. II
Army U.S. Army

Charles
May 4, 1872
July 1, 1945

Carl
Aug 8, 1901
Dec 10, 1995
Wilma
Mar. 18, 1905
Feb. 27, 1998

John
Aug 27, 1951
Apr 16, 1938
Rebecca
Aug 7, 1842
Mar. 31, 1922

1872-1942
1883-1969
1916-9

Edith Franklin
John
May 17, 1921
1921

Peoples Com.

George Michael Hoffman

b. 12 May 1960

Wife - Theron Sharp

Parents - Mary Virginia Edie

Raymond Lee Hoffman

Parents' residence - Dennison, OH

Shirley Jean Edie Bittiker

FGS from

First family file

Daughter of William Byron Edie

Son of James Lafayette Edie

Minda Pearl Edie

b. 22 Dec 1884

Dennison, OH

d. 31 Oct 1968

Early marriage of Jeff. C.

Ruth Taylor m. Geo. Chadwell Jul. 19, 1818

1830 Census - OH - Wash. Twp. Free. Co.

Fig. 15 - William Edie

Males

10-15 2

15-20 1

20-30 1

4-50 1

Females

5-10 3

15-20 2

20-30 2

40-50 1

George Edie - death record

d. 1-23-1939 - (widower)

died at New Ohio, Free. Co., OH

Father - Wm. Edie
Mother - Pearl Chadwell
His occupation - Proprietor
of flour mill

George Michael Hoffman
b. 12 May 1960
Wife - Theron Sharp
Parents - Mary Virginia Edie
Raymond Lee Hoffman
Parents' residence - Dennison, OH

George Michael Hoffman
b. 12 May 1960
Wife - Theron Sharp
Parents - Mary Virginia Edie
Raymond Lee Hoffman
Parents' residence - Dennison, OH

Ascetator Chart

Name of Compiler Shirley Bitticker Person No. 1 on this chart is the same person as No. _____ on chart No. _____

Address 1860 Johnstown Rd. N.E.
 City, State Dover, Ohio 44422
 Date 27 July 1993

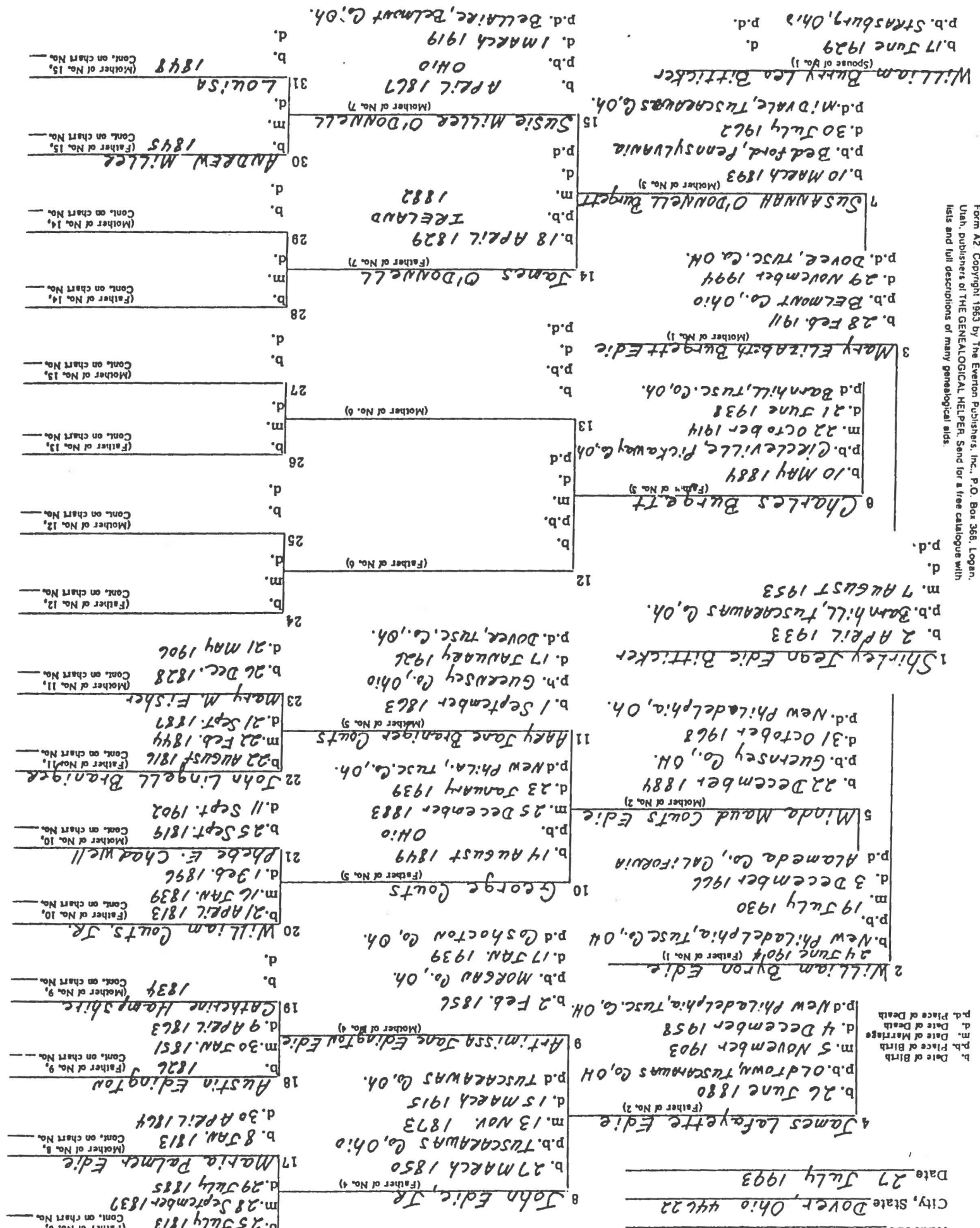

Chart No. 2

Will of George Chadwell

...day of June in the year of our Lord One thousand Eight hundred & Forty...

The last will and testament of George Chadwell, deceased, late of the County of...

...witnessed and signed with such will, and in presence of the said witnesses...

...and as you shall require for acceptance of the trust of executing said will...

...to be used as aforesaid according to law with such will, and in presence of...

...of said will, in witness whereof I have hereunto set my hand and seal...

...of said will, in witness whereof I have hereunto set my hand and seal...

...of said will, in witness whereof I have hereunto set my hand and seal...

...of said will, in witness whereof I have hereunto set my hand and seal...

...of said will, in witness whereof I have hereunto set my hand and seal...

...of said will, in witness whereof I have hereunto set my hand and seal...

MICROFILMED

For the reasons stated in the Report of the County of ... State of Ohio

to avoid such ... the day and year ...

General Court

in the premises of such ... the day and year ...

Ohio State of Ohio ... the day and year ...

to avoid such ... the day and year ...

General Court

in the premises of such ... the day and year ...

Ohio State of Ohio ... the day and year ...

No. 1859

to avoid such ... the day and year ...

General Court

in the premises of such ... the day and year ...

Wife of George Chadwell

2nd of June and deems to my said wife some Charles and Ruth Chadwell and to my said lady Mrs. Charles and Elizabeth and all the members of the records of the sale of my property contained in the third term, and all the proceeds of what I may be heard at the time of my record, after deducting the pay shall be to the creditors for that my said wife and testimony, giving and giving to the former will make by me and all my said wife and testimony, giving and giving to the said wife and testimony.

John Smith, of hereby certified and affirm my said wife Ruth Chadwell and Thomas Chadwell to be the creditors for that my said wife and testimony, giving and giving to the former will make by me and all my said wife and testimony, giving and giving to the said wife and testimony.

George Chadwell, of hereby certified and affirm my said wife Ruth Chadwell and Thomas Chadwell to be the creditors for that my said wife and testimony, giving and giving to the former will make by me and all my said wife and testimony, giving and giving to the said wife and testimony.

John Smith, of hereby certified and affirm my said wife Ruth Chadwell and Thomas Chadwell to be the creditors for that my said wife and testimony, giving and giving to the former will make by me and all my said wife and testimony, giving and giving to the said wife and testimony.

Trust of executing said will, It is thereon further ordered by the Court that letters
are to issue to him upon his giving bonds in the sum of \$600.00 and according
law with Jacob E. Spitzer and Charles E. Stuebner freeholders as securities who are approved
the Court as such; The Court approved Peter Everhardt, John Wyles and Jacob E. Spitzer as
of the personal estate of the said testator; And thereupon said Mary March widow of
John March deceased, do open Court; and after being fully advised by the Court of the
wishes known her choice and election to her widowed of the lands of her deceased husband
the law; and to retain such share of the personal estate as she should be entitled to by
said her husband had died intestate leaving children in preference to the provisions
will in her behalf made, and requested that her said refusal to take under said will be
and which is accordingly so done;
A Record. Attest;

M. W. Patrick, Notary

Will of George Chadwell

I George Chadwell of the county of Tuscarawas and State of Ohio do make and publish
my last will and testament in manner and form following, that is to say,
First, It is my will that my funeral expenses and all my just debts be fully paid
Second, I give devise and bequeath to my beloved wife Ruth Chadwell and my daughter
Malena Chadwell the tract of land in which I now reside containing about fifty
being the North part of Seat Number twenty one in quarter Township Number two of
Number five, of Range Number two of Military Land in said county also the South half
Number twenty two in said township containing fifty acres, during their natural lives
the household and kitchen furniture also one horse, two cows, two sheep and five hogs to
be them and to be their choice of the stock of which I may be the owner at the time of my
during the term of their natural lives of child property both real and personal to be held
said wife Ruth Chadwell and my said daughter Malena Chadwell jointly and several
lives, and by the surviving one singly from the death of the other until her death; And
death of my said wife or daughter surviving the other said real property hereby devised
ed to them and so much of said personal property hereby bequeathed to them as may
them, to my children ~~George Chadwell~~ Ben James Chadwell I Duffel Chadwell and to my
Philip Smith, Angelina Turner and Elizabeth Murphy all sharing equally and alike, the
same to be in lieu of dower to my said wife.

Third, It is my will that all my property both real and personal, not herein before
be sold at public sale and of the proceeds there be paid to my Grand daughter ~~and her~~
daughter ~~Elizabeth Chadwell~~ Elizabeth Chadwell One hundred dollars when she arrives to the age of
years, which said sum I hereby will and bequeath to her to be paid at said time
interest;

Fourth, I give and devise to son Thomas Chadwell one dollar to be paid out of the
of the sale of my property abovesaid.

1890- CENSUS - UNITED STATES

State Ohio

County Lucas City Wapakoneta

Commissioner Walter W. Blake

Call No. _____

Head of Family	Free White Males											Free White Females				Slaves	Free Colored	Foreigners not naturalized																																	
	Under 5	5-10	10-15	15-20	20-30	30-40	40-50	50-60	60-70	70-80	80-90	90-100	Over 100	Under 5	5-10				10-15	15-20	20-30	30-40	40-50	50-60	60-70	70-80	80-90	90-100	Over 100																						
16 George Chadwell	2	1	-	-	-	1	-	-	-	-	-	-	-	-	-	1	-	-	-	1	-	-	-	-	-	-	-	-	-	-	-	-	-	-	-	-	-	-	-	-	-	-	-	-	-	-	-	-			

3/11/2020

Ancestor Chart

p. 2

-father of #16

James Edie
b. 20 Nov 1782
m. 1803
d. 02 Nov 1849
Mary (Ward) Edie
b. 31 Aug 1780
d. 21 Aug 1833

father of #17

James Palmer
b. 05 Dec 1777
m. 12 Feb 1812
d. 24 Jan 1858

Margaret (Arnold) Palmer
b. 8 Jan 1788 Green Co., PA
d. 02 Feb 1871 Buchanan Co., IA

-father of #20

William Coutts, Sr.
b. 1781 New Jersey
m. 04 Oct 1804
d. 07 Mar 1865
Jane (Huey) Coutts
b. 1783 New Jersey
d. 25 Nov 1865

-father of #21

George Chadwell
b. 15 Apr 1798 Fauquier Co., VA
m. 19 Feb 1818
d. 13 May 1868
Ruth R. (Taylor) Chadwell
b. 05 Jun 1799
d. 02 Jan 1891

Elizabeth (Gutridge) Chadwell

b. 1778
d. 20 Oct 1829 Tusc. Co., Ohio
Ruth R. (Taylor) Chadwell's Parents
Thomas Smith Taylor
b. 10 May 1743
d. 14 Dec 1829 Tusc. Co., Ohio
Magdalena (Supplee) Taylor
b. 06 Sept 1754
d. 06 Aug 1836

Mary Wigham (Buchanan)

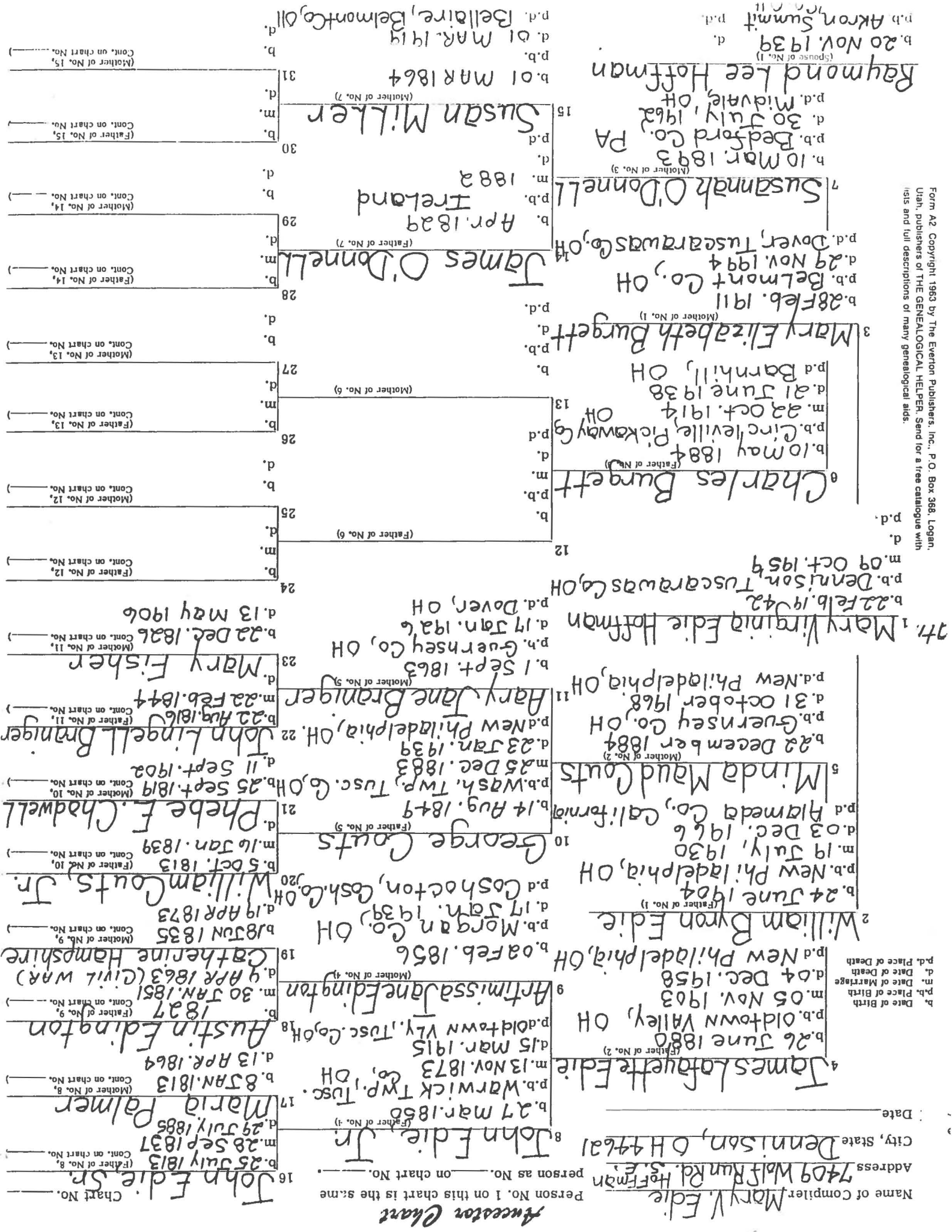

Que. Co. History 1988

1910 - Elias / Addy

William "Brook" Cuto mar. Elizabeth Ross.
Their dau. - Mary Jane Cuto.

Mary Jane Cuto mar. Robert Playford Elias
Robert Elias b. 4 Nov 1874 (son) of Zebulon

Zebulon Elias + Anna Shraw (offspring)

Mary Jane + Robert Elias 5ch -

1. Frank C. Elias

2. Ralph Elias (father of Helen Elias Addy)

3. Etta Elias

4. Anna Elias

5. Frank Elias b. 10 Feb. 1910

(Ralph's ^{4th} half-sister - Myrtle Cuto Shraw)

Ralph Elias mar. b. 12 Mar 1899 - d. 10 Jul 1967

Res. @ West Lawn Cem.

Ralph mar. Gladys Margaret Shraw b. 12 Dec 1905

d. 4 Feb 1980

Ralph + Gladys 2ch - (2)

1. Roger Myron Elias

2. Helen Fern Elias

Roger Elias mar. Dorothy Ann Pennington
Roger b. 18 Jan 1926

Roger + Dorothy - 4ch -

Anna; Greg; Steve + Susan

Helen Elias mar. Paul Kenneth Addy on

25 Nov 1945 - (Paul b. 22 Jun 1925)
Paul - son of Mary Rose + Joseph Arthur Aldy
Paul + Helen have 3 ch -

1. Larry Kenneth Aldy b. 28 Sep. 1947
2. Jean Lynn Aldy b. 11 May 1953
3. Jill Ann Aldy b. 23 Jun 1958

Larry Aldy mar. Patricia Ann Pearce dau.
of Mary Linda + Glenn Pearce
Larry + Patricia - 2 ch -

Harvie Ann b. 4 Feb 1977

Raymond Paul b. 22 Nov 1980

Joan Aldy mar. Steven Allen Zorn 31 Aug 1974
Steven - son of Mildred Zorn + Joseph Zorn
No ch. (1988)

Jill Aldy mar. Steven Scott Herder 7 Aug 1976
Steven - son of Mary Lou Obermiller + Joseph
Herder of Jeffrey, S.C.
No ch. (1988)

Ho. Charles Jamieson
son, but not Mary (Pitt)

877 - grand son
736 - grand son

Ella Mae Murray (15 Apr 1900) George Guts
b. 27 June 1883

m. 1st time
Guts

1. Raymond Guts m. Wilma Walter

b. 8 Aug 1901

children -
a. Edith

b. Mary

c. Kerry - gm, Rose

d. Bernice - Raymond & Helen

e. George - Wayne & Johnson

2. Lloyd Raymond Guts m. Ethel Black
b. 11 Apr 1906

children

a. Maurice - Ronald & Ethel

b. Shirley - Jack, Forrest - ch - George, Jackie,
C. Karen - David + Christie

3. Edith Charlotte Guts m. C.H.G. Guts
b. 7 Sep 1911

Charlotte
m. m.
a. Johnson?

boy Richard
girl
Berrie

Ella Mae's parents - Addison Chapman Murray
b. 28 Sep 1859 d. 7 Oct 1909

+ Amanda Caroline West
m. 9 Jan 1881

~~18 Apr 1860 - 21 Oct 1895~~

~~Addison Murray son of
Margaret E. Chadwell + Gen Murray d. m. 11 Jan 1859~~

Birthday

Card shower planned for Dora Blevins

A card shower is planned for Dora L. Coutts Blevins of 696-R Maple St., Newcomerstown, O. 43832, who will celebrate her 100th birthday on Nov. 5.

Born Nov. 5, 1897, Dora worked in the Greyhound Post House and Stoffer's Restaurant, both at Newcomerstown, and operated a boarding house for many years. Her hobbies were crocheting and quilting.

Mrs. Blevins' children and their spouses are Virginia Landis of West Lafayette, Bill and Jane Coutts, Dortha Eggleston, Walter and Susie Coutts, Willard and Janet Coutts and Glenn Coutts, all of Newcomerstown, and a stepdaughter and her husband, Margaret and John Bundy of Tazewell, Va. A number of grandchildren, great-grandchildren and great-great-grandchildren complete her family.

Mrs. Blevins also has a sister, Bessie Grewell of Riverside Manor Nursing and Rehabilitation Center at Newcomerstown who will be 96 on Nov. 7.



BLEVINS

Sgt. James V. Coutts, 2/1993

James V. "Jerry" Coutts, 66, of 914 Higbee Dr. NW, Columbus, O., formerly of Newcomerstown, died Aug. 20, 1993, in Columbus Community Hospital at Columbus after a short illness.

Born Aug. 4, 1927, at Booth, O., he was a son of R. Earl Coutts of Newcomerstown and the late Wilma Stevens Coutts. He retired as a truck driver from Roadway Express and was a World War II Army veteran.

Surviving are his wife, Vivian Stiles Coutts of Columbus; four sons, Jim Coutts and Dave Coutts of Newcomerstown, Curt Coutts of Gadenhuthen and Gerald Coutts of Columbus; two daughters, Mrs. Mike (Carolyn) Tipple and Mrs. David (Kerry) Addy of Newcomerstown; one stepson, Robert Hansgen of Rollin Heights, Calif.; one stepdaughter, Donna Brobst of Columbus; three sisters, Mrs. Dayne (Jo Ann) Lehman of Newcomerstown, Mary Gaynor of Brunswick and Mrs. Raymond (Bonnie) Green of West Lafayette; 10 grandchildren; five stepgrandchildren; one great-granddaughter; and two step-great-grandchildren.

He was preceded in death by one sister and two grandchildren.

Services will be held Tuesday, Aug. 24, 1993, at 1 p.m. in Addy Funeral Home Inc. at Newcomerstown with Rev. Mark Lail officiating. Burial will be in Peoples Cemetery at Newcomerstown where military graveside services will be conducted by Newcomerstown veterans organizations.

Calling hours are Monday from 2 to 4 and 7 to 9 p.m.

Happy Birthday

June 11, 1997



AUSTIN GIBSON

Happy birthday to Austin Jeffrey "Boss" Gibson, who will be three or June 11. He is the son of Jeff Gibson and Shannon (Coutts) Gibson, both of Newcomerstown.

Grandparents are Ellen Coutts of Newcomerstown, and Jim Coutts and Laura and Dave Gibson, all of Pennsylvania.

Great-grandparents are Jane and Dane Hursey, and Lorna Coutts, all of Newcomerstown; Donna and the late Robert Schneider, South Carolina, and Lois and Gerald Gibson of Bath, O.

Austin has a sister, Amber Marie who turned six in February.



June 11, 1997

Amber,
You Did An Excellent Job This Year in Kindergarten. We Are so Proud of You. Keep Up The Good Work. We Love You. Mommy & Boss

Working on Coutts Betty Coutts Way (Dora)
line. Live in Akron.
Dear. Believe me. Xmas. Xmas. Xmas. Xmas.